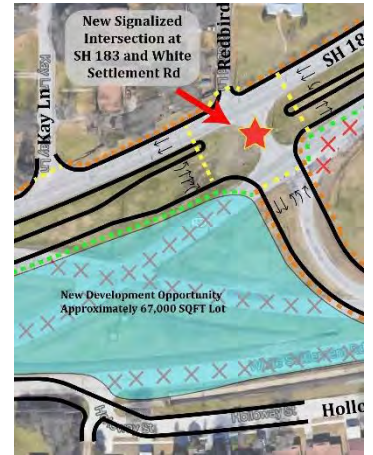
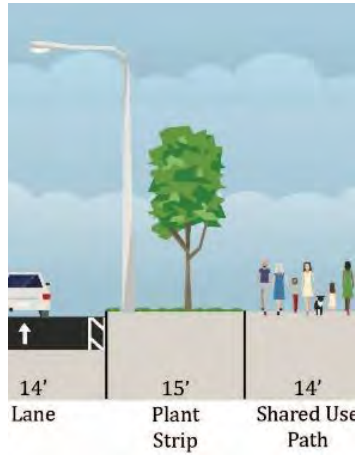


# SH 183 Corridor Master Plan

## Phase II – Trinity River to IH 30

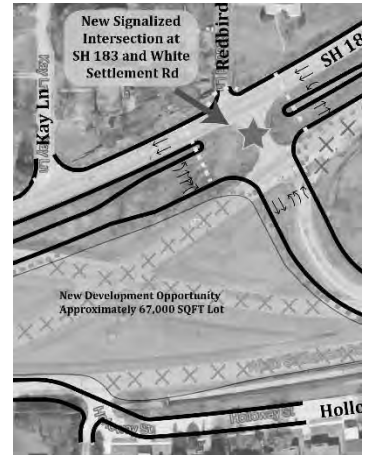
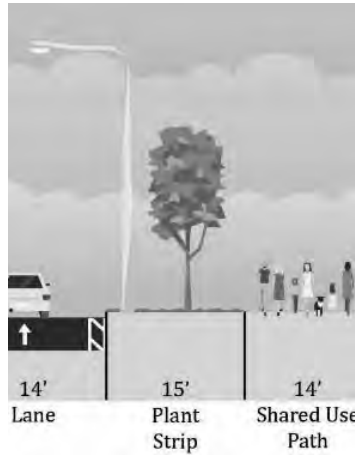


North Central Texas  
Council of Governments

January 2018

# SH 183 Corridor Master Plan

## Phase II – Trinity River to IH 30



January 2018

## NCTCOG Executive Board 2017-2018

President  
**Tom Lombard**  
Councilmember  
City of North Richland Hills

Vice President  
**Kevin Strength**  
Mayor, City of Waxahachie

Secretary-Treasurer  
**J. D. Clark**  
County Judge, Wise County

Past President  
**Lissa Smith**  
Former Mayor Pro Tem  
City of Plano

Director  
**Douglas Athas**  
Mayor, City of Garland

Director  
**Kelly Allen Gray**  
Councilmember  
City of Fort Worth

Director  
**Clay Lewis Jenkins**  
County Judge, Dallas County

Director  
**Lee M. Kleinman**  
Councilmember, City of Dallas

Director  
**Curtistene McCowan**  
Mayor, City of DeSoto

Director  
**Bobbie Mitchell**  
Commissioner, Denton County

Director  
**Nick Sanders**  
Mayor, Town of Trophy Club

Director  
**Keith Self**  
County Judge, Collin County

Director  
**Ray Smith**  
Mayor, Town of Prosper

Director  
**Paul Voelker**  
Mayor, City of Richardson

Director  
**Kathryn Wilemon**  
Councilmember  
City of Arlington

Director  
**B. Glen Whitley**  
County Judge  
Tarrant County

Director  
**Bruce Wood**  
County Judge  
Kaufman County

Ex-Officio, Non-Voting  
Member  
**Ron Simmons**  
Texas House of  
Representatives

Executive Director  
**R. Michael Eastland**

---

## Regional Transportation Council 2017-2018

**Rob Franke, P.E., Chair**  
Mayor, City of Cedar Hill

**Gary Fickes, Vice Chair**  
Commissioner, Tarrant County

**Andy Eads, Secretary**  
Commissioner, Denton County

**Douglas Athas**  
Mayor, City of Garland

**Tennell Atkins**  
Councilmember, City of Dallas

**Sara Bagheri**  
Mayor Pro Tem, City of Denton

**Carol Bush**  
County Judge, Ellis County

**Loyl C. Bussell, P.E.**  
Acting District Engineer,  
Texas Department of Transportation  
Fort Worth District

**Rickey D. Callahan**  
Councilmember, City of Dallas

**Mike Cantrell**  
Commissioner, Dallas County

**David L. Cook**  
Mayor, City of Mansfield

**Rudy Durham**  
Mayor, City of Lewisville

**Charles Emery**  
Chairman,  
Denton County Transportation Authority

**Kevin Falconer**  
Mayor, City of Carrollton

**George Fuller**  
Mayor, City of McKinney

**Sandy Greyson**  
Councilmember, City of Dallas

**Mojoy Haddad**  
Board Member, North Texas Tollway Authority

**Roger Harmon**  
County Judge, Johnson County

**Clay Lewis Jenkins**  
County Judge, Dallas County

**Ron Jensen**  
Mayor, City of Grand Prairie

**Jungus Jordan**  
Councilmember, City of Fort Worth

**Lee M. Kleinman**  
Councilmember, City of Dallas

**Harry LaRosiliere**  
Mayor, City of Plano

**David Magness**  
Commissioner, Rockwall County

**Scott Mahaffey**  
Chairman, Fort Worth  
Transportation Authority

**B. Adam McGough**  
Councilmember, City of Dallas

**William Meadows**  
Board Vice Chair  
Dallas Fort Worth International Airport

**Steve Mitchell**  
Councilmember, City of Richardson

**Cary Moon**  
Councilmember, City of Fort Worth

**Stan Pickett**  
Mayor, City of Mesquite

**Mark Riley**  
County Judge, Parker County

**Kelly Selman, P.E.**  
District Engineer  
Texas Department of Transportation  
Dallas District

**Gary Slagel**  
Board Secretary, Dallas Area  
Rapid Transit

**Will Sowell**  
Mayor Pro Tem, City of Frisco

**Mike Taylor**  
Councilmember, City of Colleyville

**Stephen Terrell**  
Mayor, City of Allen

**T. Oscar Trevino, Jr., P.E.**  
Mayor, City of North Richland Hills

**William Tsao, P.E.**  
Citizen Representative, City of Dallas

**Oscar Ward**  
Councilmember, City of Irving

**Duncan Webb**  
Commissioner, Collin County

**B. Glen Whitley**  
County Judge, Tarrant County

**Kathryn Wilemon**  
Councilmember, City of Arlington

**W. Jeff Williams**  
Mayor, City of Arlington

**Ann Zadeh**  
Councilmember, City of Fort Worth

**Michael Morris, P.E.**  
Director of Transportation, NCTCOG

---

## Surface Transportation Technical Committee

**Loyl Bussell, P.E., Chair**, Texas Department of Transportation, Fort Worth District

## What is NCTCOG?

The North Central Texas Council of Governments is a voluntary association of cities, counties, school districts, and special districts which was established in January 1966 to assist local governments in **planning** for common needs, **cooperating** for mutual benefit, and **coordinating** for sound regional development.

It serves a 16-county metropolitan region centered around the two urban centers of Dallas and Fort Worth. Currently the Council has **236 members**, including 16 counties, 168 cities, 24 independent school districts, and 28 special districts. The area of the region is approximately **12,800 square miles**, which is larger than nine states, and the population of the region is about **7 million** which is larger than 38 states.

**NCTCOG's** structure is relatively simple; each member government appoints a voting representative from the governing body. These voting representatives make up the **General Assembly** which annually elects a 17-member Executive Board. The **Executive Board** is supported by policy development, technical advisory, and study committees, as well as a professional staff of 350.



NCTCOG's offices are located in Arlington in the Centerpoint Two Building at 616 Six Flags Drive (approximately one-half mile south of the main entrance to Six Flags Over Texas).

**North Central Texas Council of Governments**  
**P. O. Box 5888**  
**Arlington, Texas 76005-5888**  
**(817) 640-3300**

### **NCTCOG's Department of Transportation**

Since 1974 NCTCOG has served as the Metropolitan Planning Organization (MPO) for transportation for the Dallas-Fort Worth area. NCTCOG's Department of Transportation is responsible for the regional planning process for all modes of transportation. The department provides technical support and staff assistance to the Regional Transportation Council and its technical committees, which compose the MPO policy-making structure. In addition, the department provides technical assistance to the local governments of North Central Texas in planning, coordinating, and implementing transportation decisions.

---

Prepared in cooperation with the Texas Department of Transportation and the U. S. Department of Transportation, Federal Highway Administration, and Federal Transit Administration.

*"The contents of this report reflect the views of the authors who are responsible for the opinions, findings, and conclusions presented herein. The contents do not necessarily reflect the views or policies of the Federal Highway Administration, the Federal Transit Administration, or the Texas Department of Transportation."*

## **EXECUTIVE SUMMARY**

The State Highway (SH) 183 (Trinity River to Interstate Highway [IH] 30) Corridor Master Plan is the culmination of planning efforts targeting northwest Tarrant County to improve mobility, increase opportunities for economic development, and provide safe and accessible transportation options for both motorized and non-motorized users. The SH 183 (Trinity River to IH 30) Corridor Master Plan is the second phase of planning for reconstruction of the SH 183 corridor. Phase I was completed with the River Oaks Boulevard Corridor Master Plan, which provided recommendations for the SH 183 corridor extending from SH 199 to the Trinity River.

The SH 183 (Trinity River to IH 30) Corridor Master Planning process included: 1) developing a detailed inventory of existing conditions along the corridor; 2) developing multiple preliminary design options for key streetscapes and intersections and presenting these to stakeholders and the public for feedback; 3) working with stakeholders to refine the design options and select a recommended design option for key streetscapes and intersections; 4) presenting the final recommended design options to stakeholders and the public for feedback; and 5) developing a report and recommendations. This final report includes streetscape and intersection improvement recommendations throughout the corridor as well as implementation steps and strategies, including an opinion of probable cost and funding strategies.

The following recommendations are identified as next steps:

1. Cities, Tarrant County and the Texas Department of Transportation (TxDOT) continue to champion the need for long- term infrastructure improvements along the corridor to improve economic development and both motorized and non-motorized mobility. Additionally, it is recommended that a SH 183 Corridor Coalition be formed to bring together the necessary parties and resources to continue to encourage implementation of the plan and to identify funding and other resources.
2. With a TxDOT on-system facility such as this one, the next step is to produce a schematic-level engineering design (30 percent design), including a hydraulics and

hydrology study, and environmental document. The entire corridor from IH 30 to SH 199 should be included in the design. It is recommended that the subsequent environmental and engineering studies follow a context-sensitive solutions approach to include urban design and redevelopment strategies to the degree possible during the development of the preliminary design. TxDOT anticipates beginning engineering in 2018.

3. Pedestrian mobility can immediately be improved along the corridor through re-striping and re-painting of the pavement along the entire roadway or, at a minimum, at the signalized intersections to include crosswalks.
4. To traverse this corridor, vehicles must travel through eight signalized intersections between the Naval Air Station Fort Worth Joint Reserve Base (NAS Fort Worth JRB) and IH 30. Coordination of traffic signals and traffic signal retiming can reduce the number of stops along a corridor and provide for a continuous flow of traffic at the target speed.
5. Based on the recommended improvements, the preliminary construction cost has been estimated at \$45.4 million (in 2017 dollars). It is recommended that agencies work to develop a phasing plan for the entire SH 183 corridor, from IH 30 to SH 199, with segments to submit for federal, state, and regional funds as opportunities become available.

## TABLE OF CONTENTS

I.	Existing Conditions .....	I-1
	EXISTING AREA PLANS .....	I-1
	Joint Land Use Study (2008).....	I-1
	Joining Forces: Regional Joint Land Use Study Existing Conditions Report (2017) .....	I-2
	Planning for Livable Military Communities (2013).....	I-3
	Mobility 2040: The Metropolitan Transportation Plan for North Central Texas (2016).....	I-4
	Westworth Village Comprehensive Vision Plan (2013).....	I-4
	Westworth Village Parks and Trails Plan (2014).....	I-5
	White Settlement Comprehensive Vision Plan (2013) .....	I-7
	Fort Worth Comprehensive Plan (2017).....	I-8
	Bike Fort Worth – Comprehensive Bicycle Transportation Plan (2009) .....	I-9
	Walk Fort Worth – Pedestrian Transportation Plan (2014) .....	I-10
	Fort Worth Master Thoroughfare Plan (2016).....	I-11
	Fort Worth Transportation Authority Master Plan (2015) .....	I-12
	DEMOGRAPHICS .....	I-12
	Population.....	I-12
	Income.....	I-16
	Employment.....	I-16
	LAND USE CONDITIONS .....	I-17
	Corridor Parcels.....	I-17
	Land Use .....	I-21
	Zoning.....	I-23
	TRANSPORTATION CONDITIONS .....	I-26
	Existing Right-of-Way and Cross Section.....	I-26
	Topography.....	I-27
	Bicycle System.....	I-29

Pedestrian System.....	I-34
Traffic Signal Operations.....	I-35
Transit System.....	I-37
Automobile, Bicycle, and Pedestrian Crashes and Traffic Volumes.....	I-42
PUBLIC AND STAKEHOLDER VISION.....	I-44
Public Involvement.....	I-44
II. Corridor Recommendations.....	II-1
SUMMARY OF RECOMMENDATIONS .....	II-1
Corridor-wide Improvements .....	II-1
River Access Context Zone.....	II-2
Base Context Zone .....	II-2
Commerce Context Zone .....	II-2
Overall Bicycle and Pedestrian Safety Countermeasures .....	II-5
RIVER ACCESS ZONE.....	II-9
Recommended Streetscape Design Option .....	II-9
Trinity River Access .....	II-10
SH 183/White Settlement Road Intersection .....	II-15
BASE ZONE.....	II-19
Recommended Streetscape Design Option .....	II-19
SH 183/Pumphrey Drive Intersection .....	II-20
NAS Fort Worth JRB Base Entrance – Future Bus Stop and Turnaround .....	II-22
COMMERCE ZONE .....	II-28
Recommended Streetscape Design Option .....	II-28
SH 183/IH 30 Interchange.....	II-35
CORRIDOR SIGNAL OPERATIONS.....	II-38
IMPLEMENTATION STEPS AND STRATEGIES .....	II-39
Near-Term Implementation and Cost .....	II-39



Long-Term Implementation and Cost ..... II-40

Funding Strategies ..... II-41

III. Appendix ..... III-1

    A. COMMUNITY MEETING SUMMARIES ..... III-1

    B. VISUAL PREFERENCE SURVEY (FULL) RESULTS AND CHARTS ..... III-2

    C. DESIGN GUIDELINES ..... III-9

    D. BICYCLE AND PEDESTRIAN SAFETY, ACCOMMODATIONS, AND LINKAGES ..... III-13

**TABLE OF EXHIBITS**

EXHIBIT I-1: Existing Area Plans ..... I-1

EXHIBIT I-2: NAS Fort Worth JRB Area Improvements ..... I-3

EXHIBIT I-3: Park Recommendations (Westworth Village Parks and Trails Plan) ..... I-6

EXHIBIT I-4: Bicycle and Pedestrian Facilities (Westworth Village Parks and Trails Plan) ..... I-7

EXHIBIT I-5: Long-Term Street Network (White Settlement Comprehensive Vision Plan) ..... I-8

EXHIBIT I-6: Western Hills/Ridglea Land Use Sector (Fort Worth Comprehensive Plan) ..... I-9

EXHIBIT I-7: Bike Fort Worth Facilities (Bike Fort Worth) ..... I-10

EXHIBIT I-8: Commercial Connector (Fort Worth Master Thoroughfare Plan) ..... I-11

EXHIBIT I-9: Demographic Levels of Geography ..... I-14

EXHIBIT I-10: Percent Male and Female ..... I-15

EXHIBIT I-11: Age and Sex ..... I-15

EXHIBIT I-12: Race and Ethnicity ..... I-15

EXHIBIT I-13: Income ..... I-16

EXHIBIT I-14: NCTCOG Employment Forecast ..... I-17

EXHIBIT I-15: Parcel Value per Square Foot ..... I-17

EXHIBIT I-16: Land and Improvements Value, Number of Parcels ..... I-18

EXHIBIT I-17: Land and Improvements Value ..... I-19

EXHIBIT I-18: Property Ownership ..... I-20

EXHIBIT I-19: Land Use (2010) ..... I-22

EXHIBIT I-20: Current Zoning ..... I-25

EXHIBIT I-21: Existing Typical Right-of-Way (With Bomber Spur) ..... I-26

EXHIBIT I-22: Existing Typical Right-of-Way (Without Bomber Spur) ..... I-26

EXHIBIT I-23: Corridor Topography ..... I-28

EXHIBIT I-24: Bicycle Facility Examples ..... I-29

EXHIBIT I-25: Bicycle Facilities ..... I-32

EXHIBIT I-26: Highlighted Segments ..... I-33

EXHIBIT I-27: Retimed Signalized Intersections (2008/2012) ..... I-35

EXHIBIT I-28: Pedestrian and Intersection Facilities ..... I-36

EXHIBIT I-29: FWTA Bus Routes and Stops ..... I-38

EXHIBIT I-30: Transit Trips Origin by TSZ ..... I-40

EXHIBIT I-31: Transit Trips Destination by TSZ ..... I-41

EXHIBIT I-32: Crash Density and Traffic Volumes ..... I-43

EXHIBIT I-33: SH 183 Corridor Crashes (Source: TxDOT CRIS 2011-2015) ..... I-44

EXHIBIT I-34: Top Scoring Images from the Visual Preference Survey ..... I-48

EXHIBIT II-1: Context Zones and Key Areas ..... II-4

EXHIBIT II-2: Example of Pavement Treatments for Separating Users on Dual Pathways ..... II-7

EXHIBIT II-3: Example of Mid-Block Path-Roadway Crossing ..... II-8

EXHIBIT II-4: River Access Context Zone Street Cross Sections – Existing and Recommended Design Option ..... II-12

EXHIBIT II-5: River Access Context Zone – Trinity River Trail Access Existing Conditions ... II-13

EXHIBIT II-6: River Access Context Zone – Trinity River Trail Access Recommended Design Option ..... II-14

EXHIBIT II-7: River Access Context Zone – SH 183/White Settlement Road Intersection Existing Conditions ..... II-17

EXHIBIT II-8: River Access Context Zone – SH 183/White Settlement Road Intersection Recommended Design Option ..... II-18

EXHIBIT II-9: Base Context Zone Street Cross Sections – Existing Conditions and Recommended Design Option ..... II-24

EXHIBIT II-10: Base Context Zone – SH 183/Pumphrey Drive Intersection Existing Conditions II-25

EXHIBIT II-11: Base Context Zone SH 183/Pumphrey Drive Intersection Recommended Design Option ..... II-26

EXHIBIT II-12: Base Context Zone NAS Fort Worth JRB Entrance Bus Stop and Turnaround Design Concept ..... II-27

EXHIBIT II-13: Commerce Context Zone Street Cross Sections - Existing Conditions and Recommended Design Option ..... II-30

EXHIBIT II-14: Linear Park Concept..... II-31  
EXHIBIT II-15: Connected Park System Concept..... II-32  
EXHIBIT II-16: Ridgmar Mall Area Property Ownership ..... II-34  
EXHIBIT II-17: Commerce Context Zone – SH 183/IH 30 Interchange Design Concept..... II-37  
EXHIBIT II-18: Preliminary Estimates of Probable Cost ..... II-41

## I. EXISTING CONDITIONS

### EXISTING AREA PLANS

The following section consists of a brief summary of existing conditions for the study area such as: existing area plans, demographics, land use conditions, and transportation conditions. Existing area plans are summarized in EXHIBIT I-1.

#### EXHIBIT I-1: Existing Area Plans

<b>Geographic Area</b>	<b>Title of Plan / Report</b>
NCTCOG	Joint Land Use Study
NCTCOG	Joining Forces: Regional Joint Land Use Study
NCTCOG	Planning for Livable Military Communities
NCTCOG	Mobility 2040: The Metropolitan Transportation Plan for North Central Texas
City of Westworth Village	Westworth Village Comprehensive Vision Plan
City of Westworth Village	Westworth Village Parks and Trails Plan
City of White Settlement	White Settlement Comprehensive Vision Plan
City of Fort Worth	Fort Worth Comprehensive Plan
City of Fort Worth	Bike Fort Worth
City of Fort Worth	Walk Fort Worth
City of Fort Worth	Fort Worth Master Thoroughfare Plan
FWTA	Fort Worth Transportation Authority Master Plan

#### Joint Land Use Study (2008)

The Joint Land Use Study (JLUS) was an initiative between the North Central Texas Council of Governments (NCTCOG), Tarrant County, and the Cities of Benbrook, Fort Worth, Lake Worth, River Oaks, Westworth Village, and White Settlement. The purpose of the JLUS was to evaluate whether and how the recommendations issued in the 2002 Air Installation Compatible Use Zone Study were implemented. Recommendations for additional actions by local governments were

designed to improve land use decisions that may affect the mission of the Naval Air Station Fort Worth, Joint Reserve Base (NAS Fort Worth JRB). The JLUS developed immediate strategies and recommendations intending to:

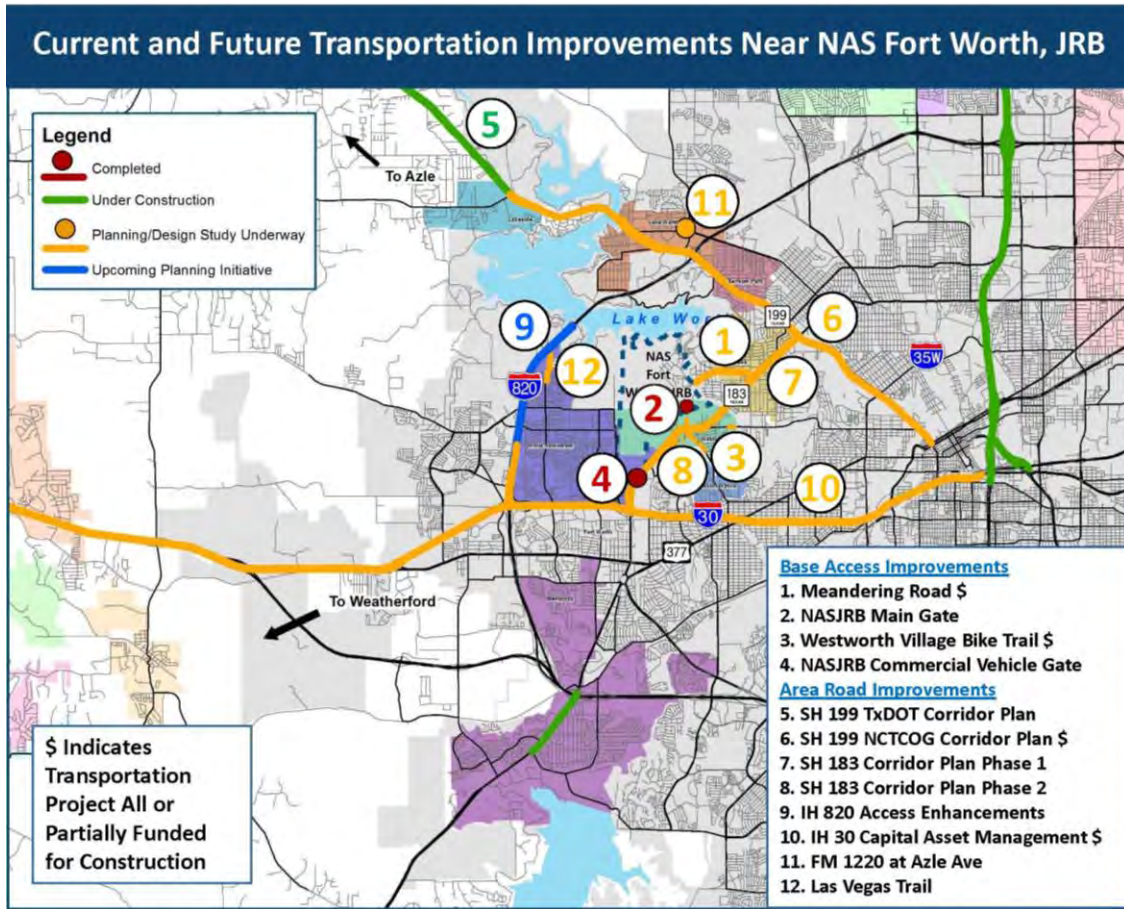
- Establish an oversight committee to monitor changes and to work closely with the base on land use and encroachment issues.
- Revise and continue to enforce current regulatory requirements such as zoning and building codes to minimize encroachment and noise issues.
- Institute noise level reduction measures and a sound attenuation program for those incompatible structures located in the high noise contours.
- Establish a real estate advisory service for the noise-affected area.
- Initiate land protection and/or acquisition in the clear zone.

Other recommendations for local governments included increased communication with the NAS Fort Worth JRB and the development of a land use oversight committee that would oversee development near the base.

**Joining Forces: Regional Joint Land Use Study Existing Conditions Report (2017)**

The Joining Forces: Regional Joint Land Use Study builds upon the momentum of ongoing regional planning and the prior JLUS study in 2008. The goals of the study are to balance the region's growth and development with military operational capabilities, address encroachment issues with new technologies such as unmanned aerial systems and renewable energy, maintain long-term viability of North Texas military facilities, and continue with the specific recommendations from the 2008 JLUS report. This report identifies the NAS Fort Worth JRB as a high-intensity operations base and maps the ongoing transportation projects surrounding the base, including this current study. NCTCOG and various regional partners are undertaking these transportation related projects to enhance access to the base and surrounding areas, shown in EXHIBIT I-2.

**EXHIBIT I-2: NAS Fort Worth JRB Area Improvements**



**Planning for Livable Military Communities (2013)**

In succession to the JLUS initiative, the Planning for Livable Military Communities (PLMC) included analysis of the regional market, housing and retail sectors, transportation system, and local ordinances; as well as Comprehensive Plan Vision reports for the Cities of Lake Worth, River Oaks, Sansom Park, Westworth Village, and White Settlement. Themes of the common goals across the six PLMC Communities included:

- Fostering economic development
- Coordinated planning along corridors
- Enhanced roadway designs and functionality for all users and emphasis on transportation infrastructure investments
- Improving bicycle and pedestrian connectivity

- Encouraging mixed uses
- Improving the ability to age in place
- Increased land use compatibility around NAS Fort Worth JRB

The PLMC also included recommendations for land use, Complete Streets programs, corridor improvements, pedestrian amenity improvements, and possible opportunities to provide public transit to the cities.

### **Mobility 2040: The Metropolitan Transportation Plan for North Central Texas (2016)**

Mobility 2040 examines future transportation needs and issues throughout the NCTCOG metropolitan planning area. Mobility 2040 identifies transportation solutions that offer travel choices to the region's residents. It provides a variety of mobility options for the present and future for creating a high quality of life in the Dallas-Fort Worth area. Mobility 2040 is the product of a comprehensive, cooperative, and continuous planning effort. SH 183 is designated in Mobility 2040 as a regionally significant arterial. The Regional Transportation Council adopted Mobility 2040 in March 2016.

### **Westworth Village Comprehensive Vision Plan (2013)**

As part of the PLMC process, a comprehensive vision plan was established for the City of Westworth Village. The central purpose of the Comprehensive Vision Plan was to reflect the values and priorities of the community on issues such as quality of life, future growth and redevelopment, and access to services. The Comprehensive Vision Plan identified commercial redevelopment areas along SH 183 and proposed bicycle and pedestrian connections that would cross SH 183. The plan created goals for economic development, land use, housing, roadway infrastructure, bicycle/pedestrian network, and public transportation. For SH 183 within the City of Westworth Village, the plan stated the number of lanes warranted by a level of service analysis in 2035 could potentially be six lanes, an increase from the existing four lanes. The comprehensive plan included a network of street connections proposed over the long term which would improve vehicular movement in the city and better align it with the planned

commercial and residential redevelopment. The plan also created more linkages for bicycle and pedestrian movement. The City Council in Westworth Village adopted the Westworth Village Comprehensive Vision Plan in December 2013.

**Westworth Village Parks and Trails Plan (2014)**

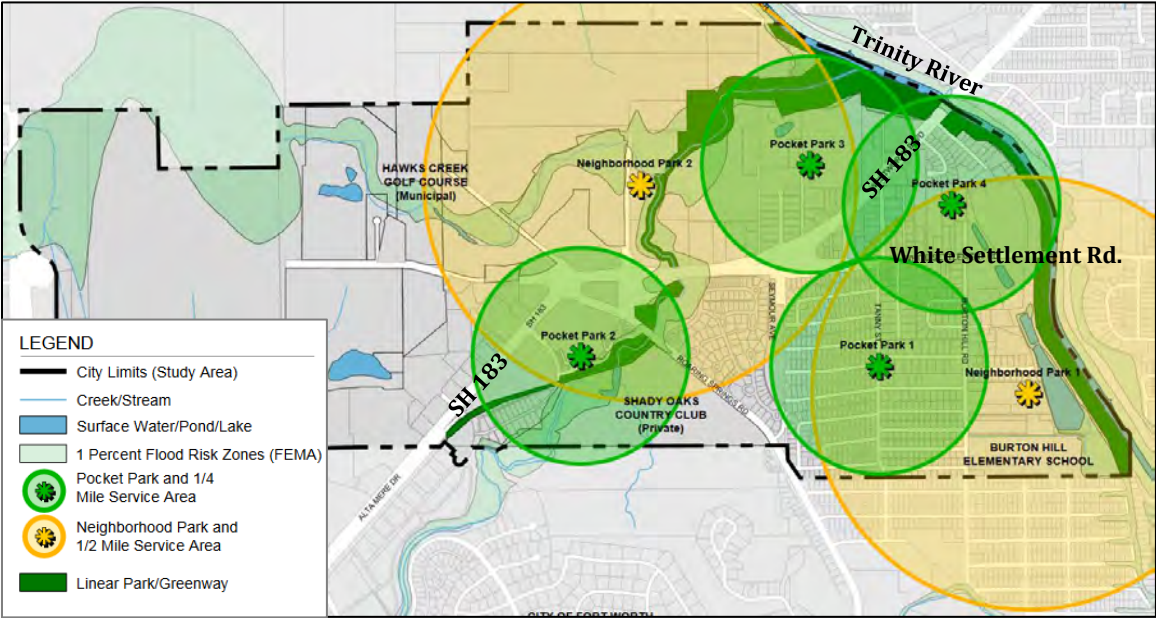
The City of Westworth Village adopted a parks and trails plan in February 2014. The plan completed a study to develop the long-term goals for parks and trails within the City of Westworth Village. Areas for smaller pocket parks and neighborhood parks were identified to serve different parts of the city, as seen in EXHIBIT I-3.

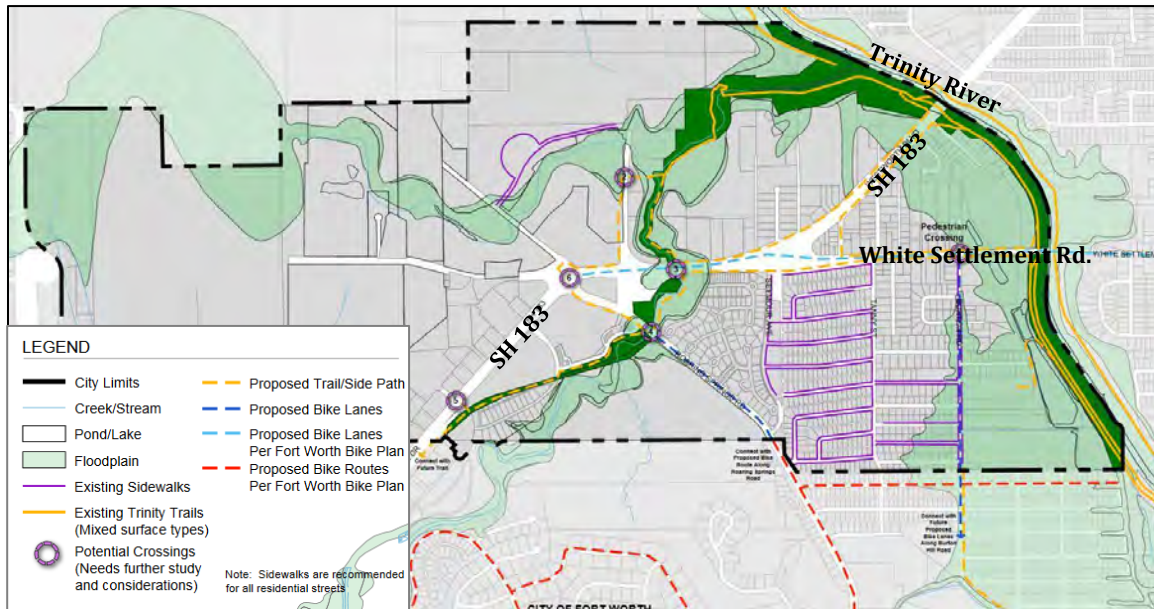
The plan shows bicycle and pedestrian facility recommendations. The plan proposed a shared-use side path along SH 183 from the Trinity River to Roaring Springs Road. The proposed Bomber Spur trail is identified on the map.



EXHIBIT I-4 shows the proposed improvements.

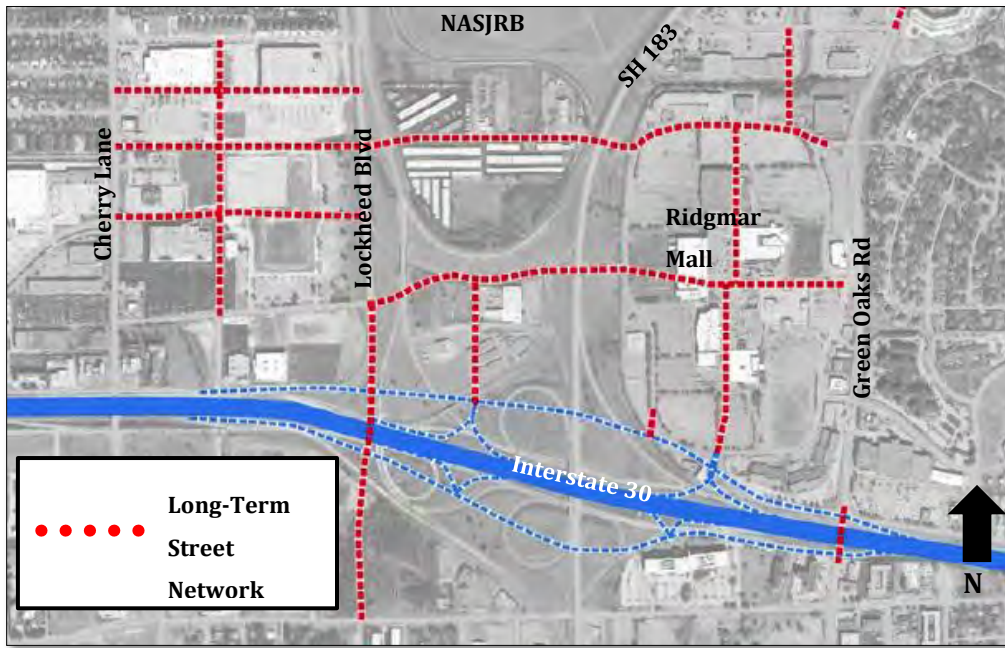
**EXHIBIT I-3: Park Recommendations (Westworth Village Parks and Trails Plan)**



**EXHIBIT I-4: Bicycle and Pedestrian Facilities (Westworth Village Parks and Trails Plan)****White Settlement Comprehensive Vision Plan (2013)**

Similar to Westworth Village, a comprehensive vision plan was established for the City of White Settlement in the PLMC process. The community of White Settlement's visioning exercise indicated a particular interest in and emphasis on redeveloping commercial areas, improving the function of local roadways, and increasing the mix and quality of local businesses. The exercise also indicated a desire to strengthen opportunities for intergovernmental coordination. Feedback from the community suggested that the priority area for redevelopment should be along Cherry Lane, and redevelopment should include a mix of retail and residential uses. The market analysis included within the Comprehensive Vision Plan identified the SH 183 corridor near the Ridgmar Mall as a catalyst site for redevelopment. For SH 183 within White Settlement, the plan stated that the number of lanes warranted by a level of service analysis in 2035 could potentially be six lanes, an increase from the existing four lanes. As shown in EXHIBIT I-5 the Comprehensive Vision Plan identified possible new roadway connections to increase mobility for all users from the heart of the city to SH 183 and other commercial areas on the east side of SH 183. The White Settlement City Council adopted the plan in December 2013.

**EXHIBIT I-5: Long-Term Street Network (White Settlement Comprehensive Vision Plan)**

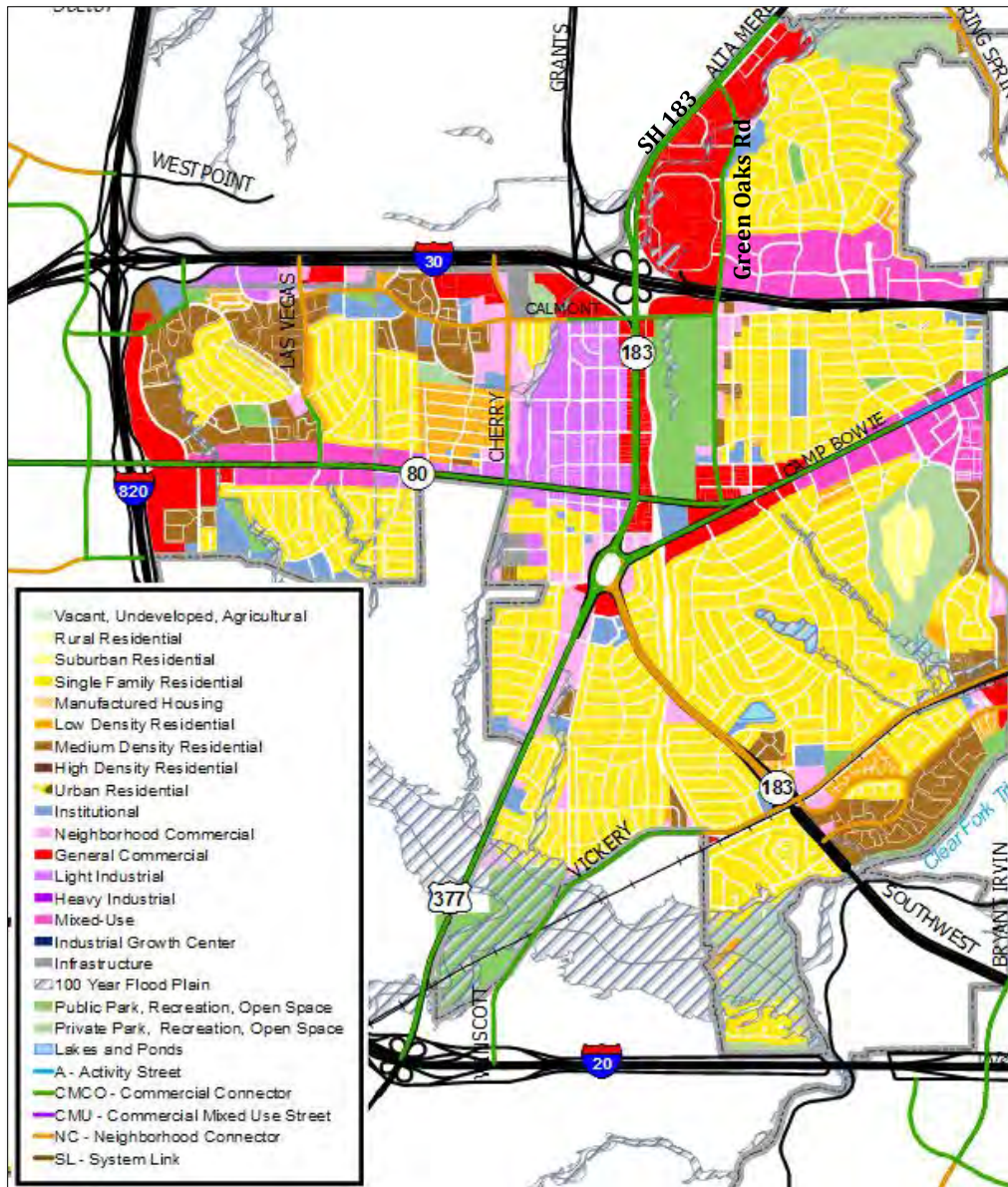


**Fort Worth Comprehensive Plan (2017)**

The City of Fort Worth’s Comprehensive Plan identifies the SH 183 corridor as a Commercial Connector in concordance with their Master Thoroughfare Plan. The corridor resides within the city’s Western Hills/Ridglea sector for future land use analysis. As shown in EXHIBIT I-6, future land use along the corridor is planned to be general commercial, which matches the existing land uses. There are two key land use policies within this sector that pertain to the SH 183 corridor:

- Incompatible uses are to be discouraged within the NAS Fort Worth JRB clear zone and accident potential zones, including the discouragement of residential uses.
- Stimulate redevelopment of commercial districts along Alta Mere Drive and Green Oaks Road.

**EXHIBIT I-6: Western Hills/Ridglea Land Use Sector (Fort Worth Comprehensive Plan)**

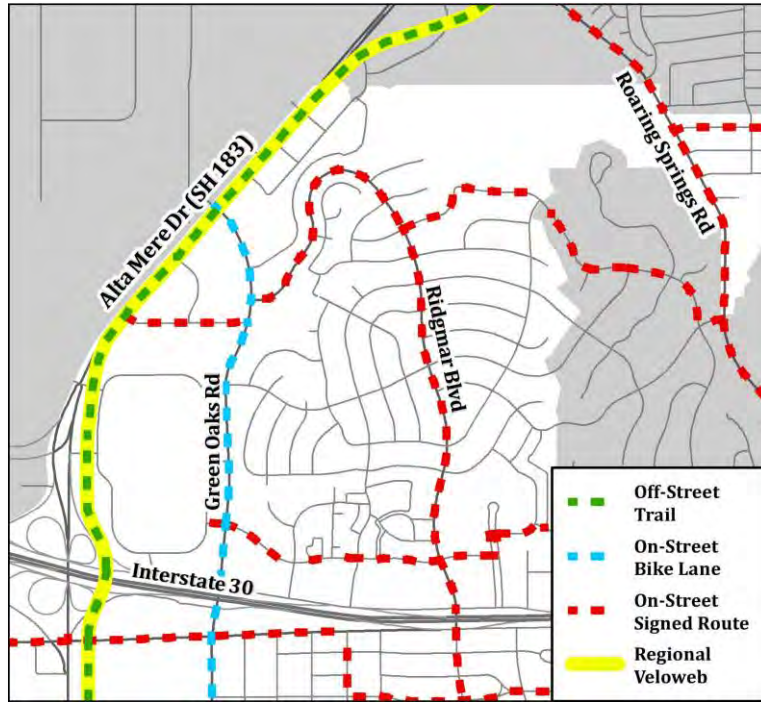


**Bike Fort Worth – Comprehensive Bicycle Transportation Plan (2009)**

Bike Fort Worth, adopted in 2009, is the City of Fort Worth’s comprehensive bicycle transportation plan that provides recommendations for policies, programs, and facilities to increase the number of bicycle users on the transportation system. Even though the plan focuses mostly on on-street facilities, the recommended network includes both on and off-street facilities. EXHIBIT I-7 shows the recommended bicycle facilities within the SH 183 corridor. The

plan recommends an off-street shared-use path along the Bomber Spur alignment parallel to Alta Mere Drive (SH 183), which is consistent with NCTCOG’s Regional Veloweb, shown in yellow on the map. Other proposed connections to the corridor are on-street bicycle lanes along Green Oaks Road and an on-street bicycle route along Ridgmar Meadow Road.

**EXHIBIT I-7: Bike Fort Worth Facilities (Bike Fort Worth)**



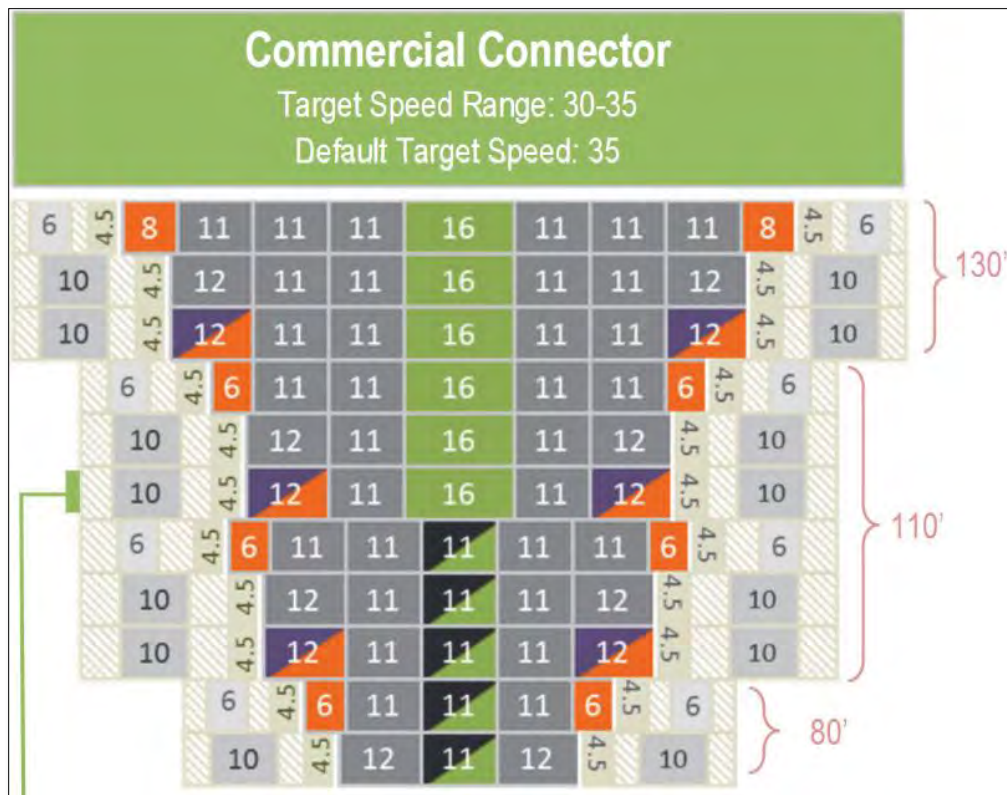
**Walk Fort Worth – Pedestrian Transportation Plan (2014)**

Walk Fort Worth is the City of Fort Worth’s comprehensive transportation plan that seeks to provide recommendations for developing pedestrian-friendly environments throughout the city. It was adopted by the City Council in 2014. The plan recommended updating the city’s Complete Streets policy, increasing the minimum sidewalk width, and designing streets for safer speeds. American Community Survey (ACS) data is cited and reported that only 1.2 percent of all transportation trips were walking trips within the City of Fort Worth in 2012, which ranks lower than nearby large cities such as Dallas and Arlington. The plan states that sidewalks along arterial roadways were one of the most requested sidewalk improvements listed in the plan. Alta Mere Drive (SH 183) is listed as a high priority corridor within the plan.

**Fort Worth Master Thoroughfare Plan (2016)**

The City of Fort Worth adopted a new Master Thoroughfare Plan in May 2016. Grounded in Complete Streets principles, there are options for street cross sections to accommodate all transportation users in any context the surrounding land use provides. SH 183, also known as Alta Mere Drive, is categorized as a Commercial Connector. The Master Thoroughfare Plan describes Commercial Connectors as “typically serving retail portions of the City with many driveways and a mixture of medians and center turn lanes.” Depending on the amount of available right-of-way, the Master Thoroughfare Plan provides cross section options for Commercial Connectors. EXHIBIT I-8 is an excerpt from the Master Thoroughfare Plan and shows the Commercial Connector cross section options. The dark grey boxes are auto lanes, green boxes are medians, orange represents bicycle lanes, purple is transit, and light grey represents sidewalks/side paths. The numbers on each box represent the element width in feet. The default target speed for Commercial Connectors is 35 mph.

**EXHIBIT I-8: Commercial Connector (Fort Worth Master Thoroughfare Plan)**



**Fort Worth Transportation Authority Master Plan (2015)**

The Fort Worth Transportation Authority's (FWTA) master plan provides recommendations for catching up to the growth that has already occurred in Tarrant County. The plan provides short-term and long-term recommendations to improve existing service, expand service to new areas, improve access to transit, and develop frequent transit lines and premium services. The master plan identifies SH 183 as a corridor for rapid bus service stretching from Ridgmar Mall to the Stockyards. Rapid bus service is defined as service along direct major roads with special branding and having frequent service with 10 to 15 minute headways. Ridgmar Mall is also anticipated to continue to function as a major transit center in west Tarrant County.

**DEMOGRAPHICS**

The following demographic data sets were developed for the one-half mile radius on either side of the corridor. The data sets were extracted from two sources: the ACS Five-Year (2011-2015) estimates and the NCTCOG Regional Demographic Forecast dataset. The corridor contains five block groups and 10 traffic survey zones (TSZs), as seen in EXHIBIT I-9. The block groups and TSZs occur within the Cities of Fort Worth, White Settlement, and Westworth Village. Both the block groups and TSZs extend beyond the immediate corridor study area, with the TSZs being slightly larger than the block groups.

**Population**

According to the ACS Five-Year (2011-2015) estimates, the total population of the study area is 5,571, which represents a two percent decrease from the population of 5,685 in 2010. The ACS reports that these block groups in the study area are 53 percent male and 47 percent female. EXHIBIT I-10 shows this information in detail by block group.

The median age of residents in this area is 40, which is higher than the county average of 34 years. The population of people aged 65 or older is 17 percent of the study area population compared to 9.9 percent in Tarrant County. The population of people aged 17 or younger is 19 percent of the study area. Tarrant County has a higher population of younger persons and a

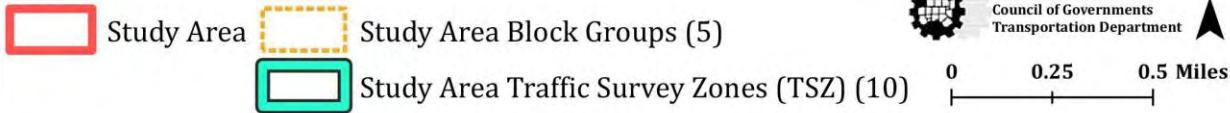
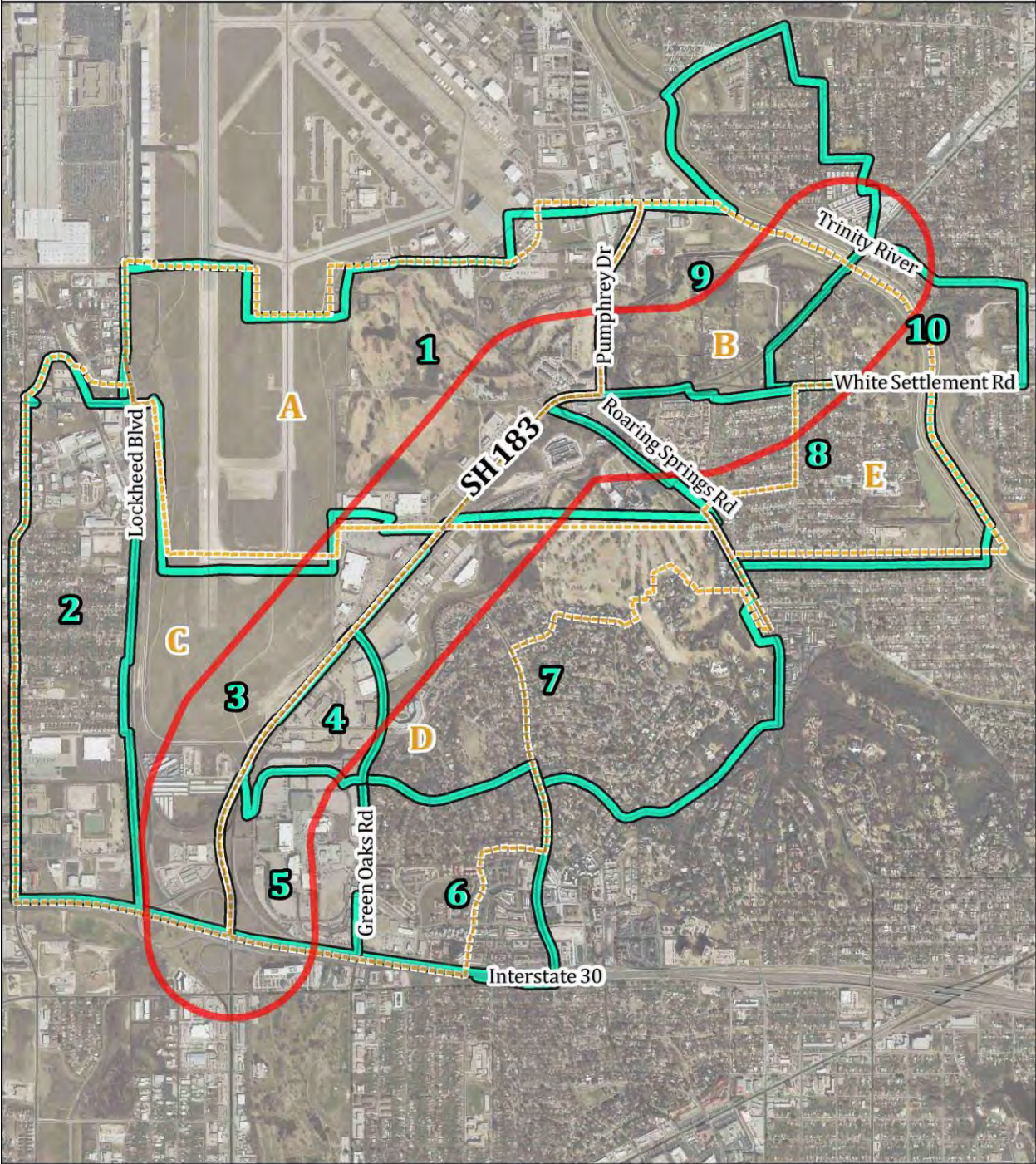
much lower percentage of those over 65. EXHIBIT I-11 shows this information in detail by block group.

Out of the 5,571 residents within the study area, 1,289 identified as Hispanic or Latino, which is 23 percent of the study area population. The largest race or ethnicity category for the study area was White alone, at 84.5 percent of the total population. EXHIBIT I-12 shows this information in detail by block group.



**EXHIBIT I-9: Demographic Levels of Geography**

**SH 183 (I-30 to Trinity River) | Demographic Levels of Geography**



**EXHIBIT I-10: Percent Male and Female**

Study Area Block Group	Map Key	Population	Male	Female	% Male	% Female
484391106001	A	754	413	341	55%	45%
484391106002	B	811	428	383	53%	47%
484391107043	C	949	569	380	60%	40%
484391230003	D	2,038	997	1041	49%	51%
484391106003	E	1,019	502	517	49%	51%
<b>Total Study Area</b>		<b>5,571</b>	<b>2,909</b>	<b>2,662</b>	<b>53% (Avg.)</b>	<b>47% (Avg.)</b>
<b>Tarrant County</b>		<b>1,914,526</b>	<b>937,226</b>	<b>977,260</b>	<b>49%</b>	<b>51%</b>

Source: US Census 2011-2015 ACS Five-Year Estimates

**EXHIBIT I-11: Age and Sex**

Study Area Block Group	Map Key	Population	Median Age	Age 65 or Older	% Age 65 or Older	Age 17 or Younger	% Age 17 or Younger
484391106001	A	754	27	27	4%	183	24%
484391106002	B	811	49	99	12%	165	20%
484391107043	C	949	42	160	17%	122	13%
484391230003	D	2,038	48	747	37%	292	14%
484391106003	E	1,019	35	154	15%	269	26%
<b>Total Study Area</b>		<b>5,571</b>	<b>40</b>	<b>1,187</b>	<b>17% (Avg.)</b>	<b>1,031</b>	<b>19% (Avg.)</b>
<b>Tarrant County</b>		<b>1,914,526</b>	<b>34</b>	<b>189,538</b>	<b>10%</b>	<b>520,751</b>	<b>27%</b>

Source: US Census 2011-2015 ACS Five-Year Estimates

**EXHIBIT I-12: Race and Ethnicity**

Study Area Block Group	Map Key	Population	White Alone	% White Alone	Hispanic or Latino	% Hispanic or Latino
484391106001	A	754	453	60%	181	24%
484391106002	B	811	598	74%	195	24%
484391107043	C	949	546	58%	295	31%
484391230003	D	2,038	1,516	74%	310	15%
484391106003	E	1,019	672	66%	308	30%
<b>Total Study Area</b>		<b>5,571</b>	<b>3,785</b>	<b>66% (Avg.)</b>	<b>1,289</b>	<b>25% (Avg.)</b>
<b>Tarrant County</b>		<b>1,914,526</b>	<b>954,181</b>	<b>50%</b>	<b>528,560</b>	<b>28%</b>

Source: US Census 2011-2015 ACS Five-Year Estimates

## **Income**

According to the ACS Five-Year (2011-2015) dataset, the median household income for the five block groups within the corridor study area was \$52,198, which is lower than the median household income for Tarrant County at \$58,711. The percentage of households that were classified as below the poverty level within the study area was 11 percent, compared to Tarrant County at 13.2 percent. EXHIBIT I-13 shows these income statistics.

### **EXHIBIT I-13: Income**

<b>Study Area Block Group</b>	<b>Median HH Income</b>	<b>Percent of Households Below Poverty Level</b>
484391106001	\$ 52,874	17%
484391106002	\$ 55,167	11%
484391106003	\$ 52,083	9%
484391107043	\$ 51,011	10%
484391230003	\$ 49,857	8%
<b>Total Study Area</b>	<b>\$ 52,198 (Avg.)</b>	<b>11% (Avg.)</b>
<b>Tarrant County</b>	<b>\$ 58,711</b>	<b>13.2%</b>

*Source: US Census 2011-2015 ACS Five-Year Estimates*

## **Employment**

Employment data for the study area was extracted from NCTCOG's Regional Demographic Forecast. The forecast provides long-range, small-area employment projections in five-year intervals through the year 2040. For the year 2017, NCTCOG's dataset estimates 10,444 jobs within the study area. The majority of these jobs, 66 percent, reside in the service sector. By the year 2040, the dataset estimates there will be an overall 40 percent increase in the number of jobs within the study area, which is lower than Tarrant County at 45 percent. The largest percent increase between 2017 and 2040 is within the retail sector at 48 percent, with service-based industry following closely behind at 43 percent. The retail sector includes sales and production of tangible goods, while in the service sector, services are provided without producing a tangible good. By the year 2040, it is forecasted that the study area will contain 14,600 jobs. With the majority of the corridor already built out, the forecasted increase in the

number of jobs could potentially impact the distribution of existing land uses within the corridor and relies on redevelopment. EXHIBIT I-14 shows this information.

**EXHIBIT I-14: NCTCOG Employment Forecast**

	<b>Year 2017</b>	<b>Year 2040</b>	<b>Percent Change (2017-2040)</b>
Basic	2,592	3,328	28%
Retail	921	1,363	48%
Service	6,931	9,909	43%
<b>Total Study Area</b>	<b>10,444</b>	<b>14,600</b>	<b>40% (Avg.)</b>
<b>Tarrant County</b>	<b>1,196,521</b>	<b>1,739,327</b>	<b>45% (Avg.)</b>

*Source: NCTCOG Regional Demographic Forecast, 2010*

**LAND USE CONDITIONS**

**Corridor Parcels**

This section analyzes parcel data from the Tarrant County Appraisal District to examine land and improvements values within the corridor study area. This section analyzes parcels that are only within the red study area boundary outline, which is a quarter-mile buffer surrounding the corridor. Thirty-six percent of parcels within the study area did not have available appraisal data. Therefore, this analysis only includes parcels where land values and improvements values were accessible. According to Tarrant County Appraisal District data, land value per square foot was an average of \$6.93 and the improvements value per square foot for the corridor was an average of \$18.30, which is summarized in EXHIBIT I-15.

**EXHIBIT I-15: Parcel Value per Square Foot**

	<b>Average Value Per Square Foot</b>
Land	\$ 6.93
Improvements	\$ 18.30

For the purposes of analysis of property values to identify potential locations for redevelopment, a parcel is generally considered underutilized and more prime for redevelopment if the value of land is greater than the existing improvements on that particular parcel. EXHIBIT I-16 details the number of these parcel categories within the study area.

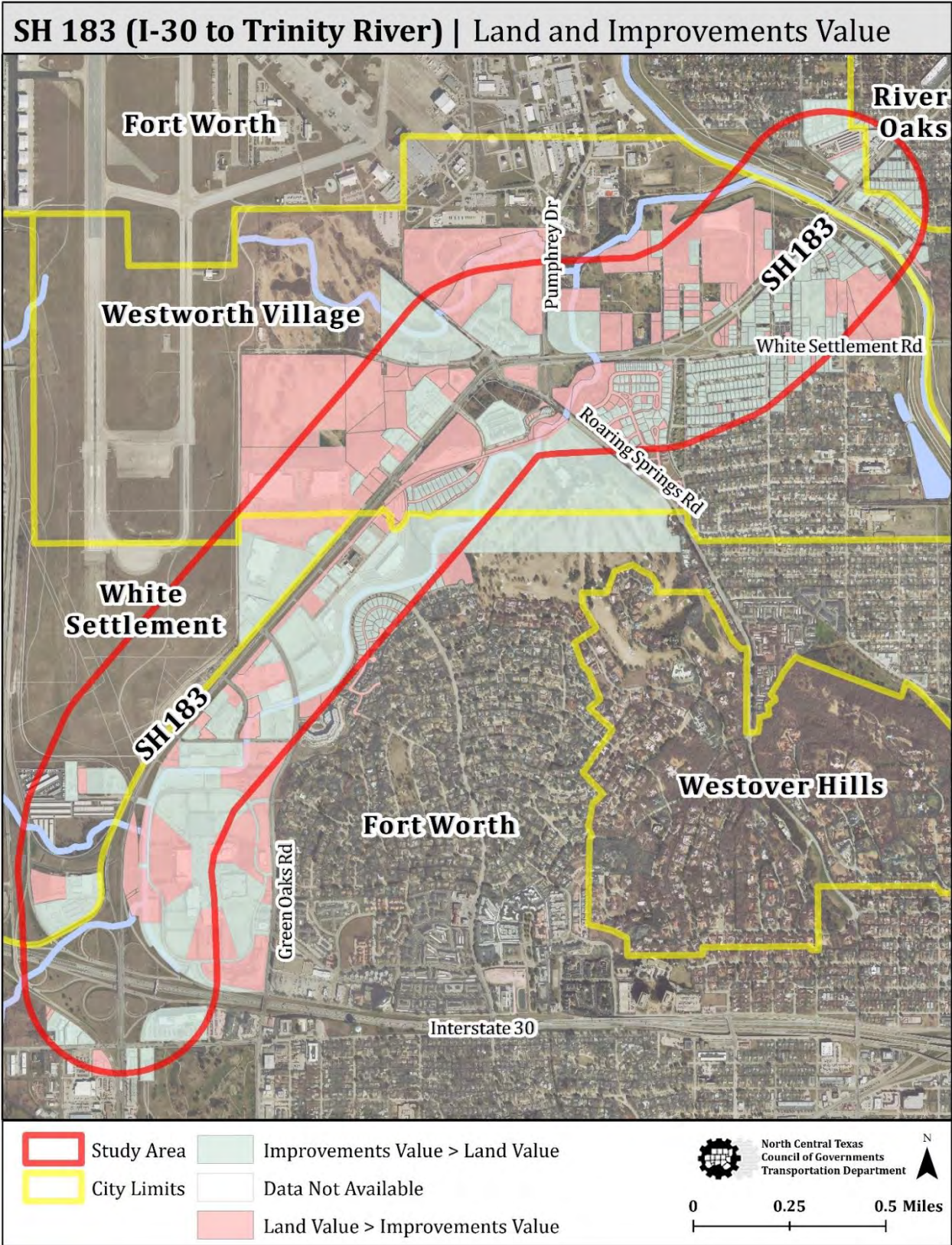
**EXHIBIT I-16: Land and Improvements Value, Number of Parcels**

	<b>Number of Parcels</b>
Improvements Value > Land Value	499
Land Value > Improvements Value	171
Data Not Available	376

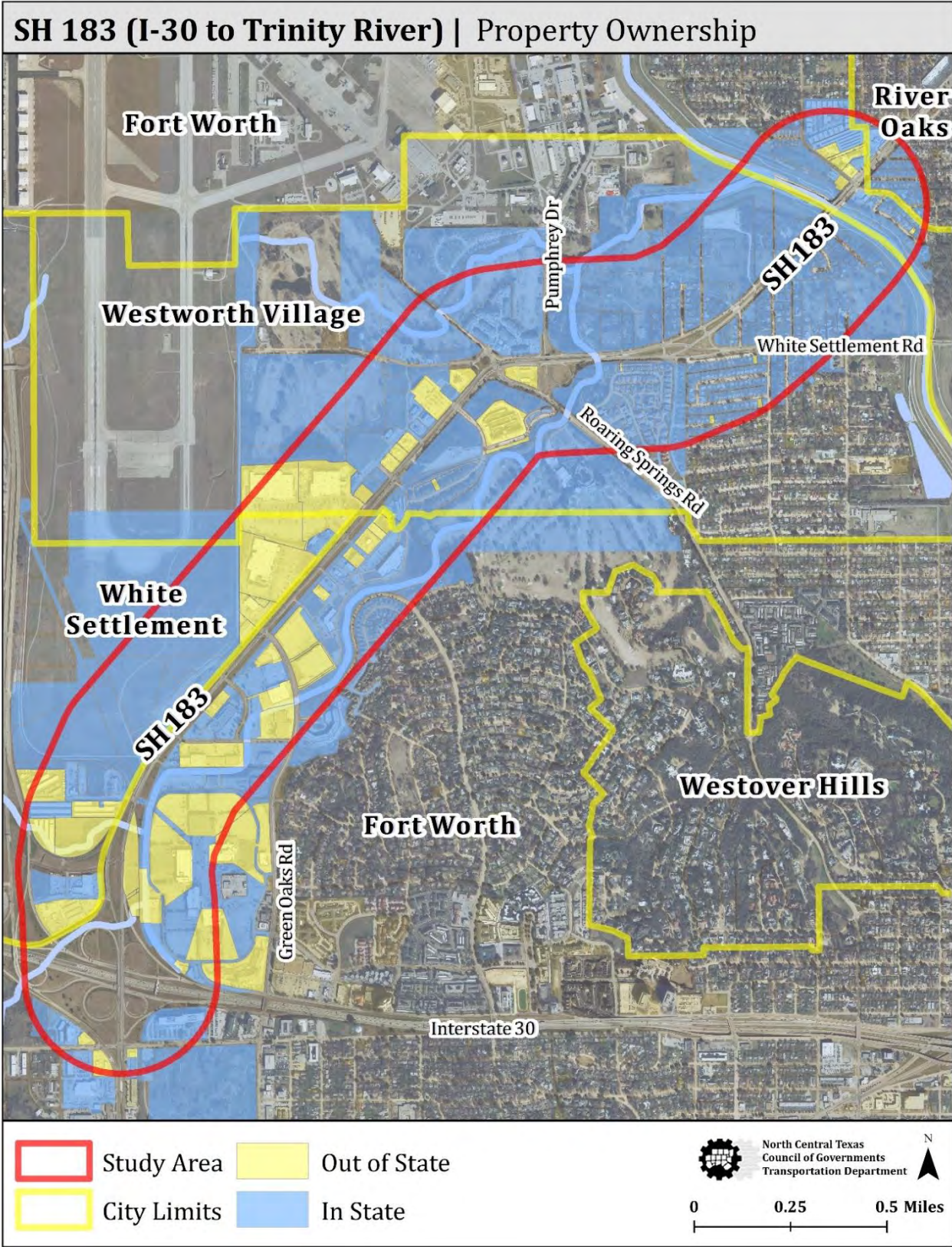
Approximately 74 percent of parcels for which data is available within the corridor study area boundary have improvements values greater than land values. The remaining 26 percent of parcels within the corridor have a land value greater than improvements value. EXHIBIT I-17 illustrates this pattern, with panels in red being highlighted as potentially more prime for redevelopment.

Another indicator for identifying parcels that could potentially redevelop is the location of the property owner. Property owners located within the State of Texas could have a greater potential to redevelop their property than owners located outside the State of Texas. EXHIBIT I-18 shows the ownership location for each parcel within the study area. The majority of the out-of-state property owners are located in the southern part of the corridor, which coincides with the larger retail/commercial focus in this area. Local in-state property ownership increases towards the northern end of SH 183, which has a greater number of single-family residential units.

**EXHIBIT I-17: Land and Improvements Value**



**EXHIBIT I-18: Property Ownership**



## **Land Use**

Commercial and retail developments are concentrated along the southern and central portions of the corridor. Ridgmar Mall is a major retail destination anchoring the southern section of the study area. The other commercial developments within the study area are generally comprised of suburban retail centers and national chains varying in size and includes stores such as Wal-Mart, Lowe's Home Improvement, Sam's Club, Target, and PetSmart.

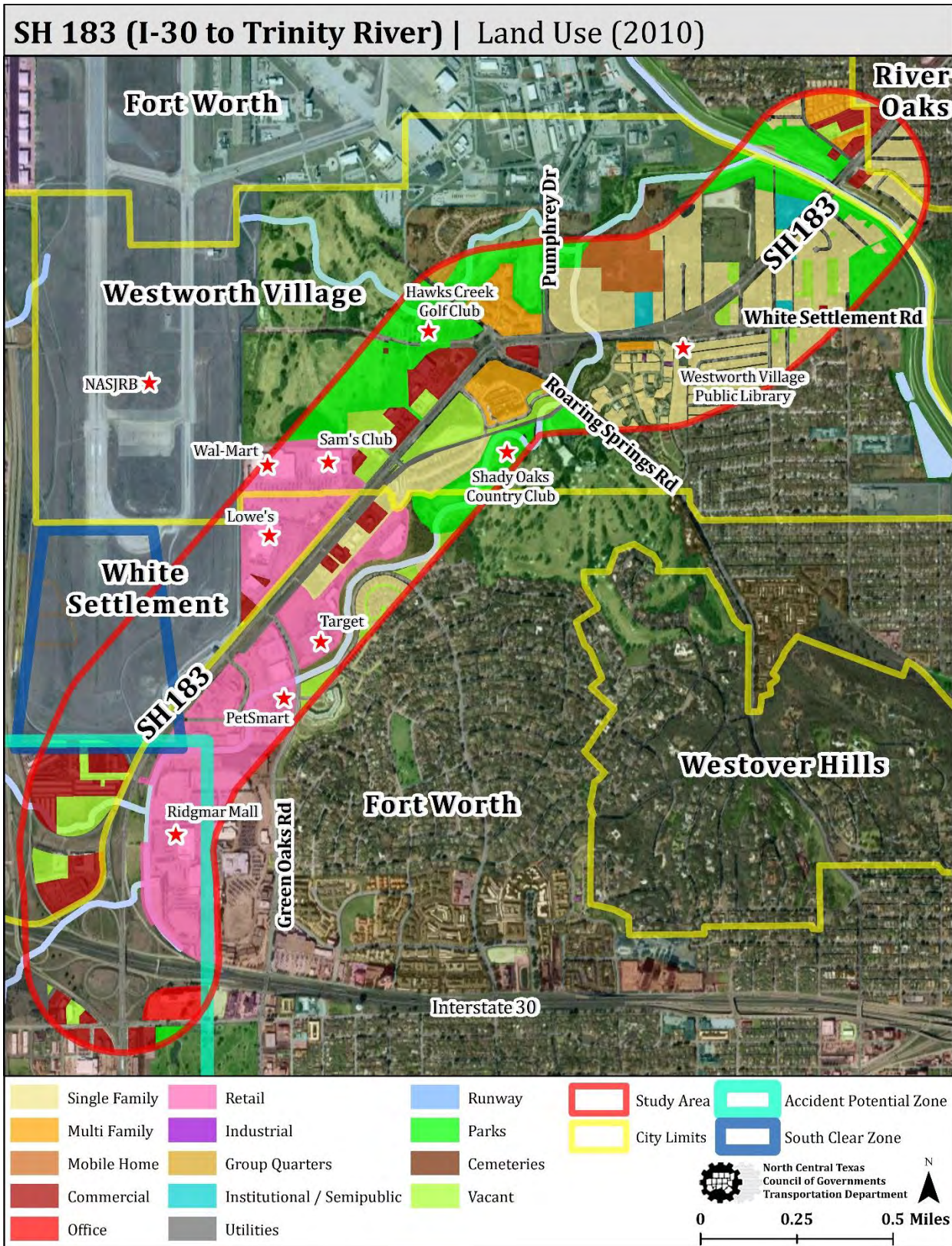
The majority of land use within the northern part of the study area is residential. This section of the corridor is within the City of Westworth Village where the residential uses are divided between single-family neighborhoods and multi-family developments. Newly constructed attached townhomes and a senior living facility, Westmore Senior Living, are located on the southern side of the intersection of Roaring Springs Road and SH 183.

Hawks Creek Golf Club in the City of Westworth Village and Shady Oaks Country Club in the Cities of Fort Worth and Westworth Village comprise the major recreational destinations in the corridor. In addition, the Westworth Village City Library is located on the southern side of the SH 183 and White Settlement Road intersection. There are no school campuses within the immediate study area.

The NAS Fort Worth JRB is located on the corridor and represents a large portion of the surrounding land use context to the north. There are two areas relating to the NAS Fort Worth JRB that could potentially impact future land uses within the corridor: the Accident Potential Zone and the Clear Zone. These are areas with a statistically higher risk of an aircraft accident due to proximity to the runway south of the NAS Fort Worth JRB. These zones provide development standards and guidelines to protect property and land uses in the vicinity of the NAS Fort Worth JRB. The City of White Settlement comprises the majority of these two zones. Any future redevelopment within the corridor in these zones would be subject to the governing ordinances related to these zones and with the JRB Regional Coordination Committee. EXHIBIT I-19 illustrates the current land uses within the study area.



**EXHIBIT I-19: Land Use (2010)**



## **Zoning**

There are three municipalities administering zoning codes along the corridor. The three cities have different zoning codes, which provides a change in context throughout the corridor. The primary general zoning categories for the corridor are commercial and industrial. The southern section of the corridor between IH 30 and Green Oaks Road is within the City of Fort Worth, and contains medium industrial zoning. Ridgmar Mall is located within this zoning district in the City of Fort Worth. The City of White Settlement fronts this section of the corridor on the west, but the NAS Fort Worth JRB comprises the majority of that frontage, with limited commercially zoned areas.

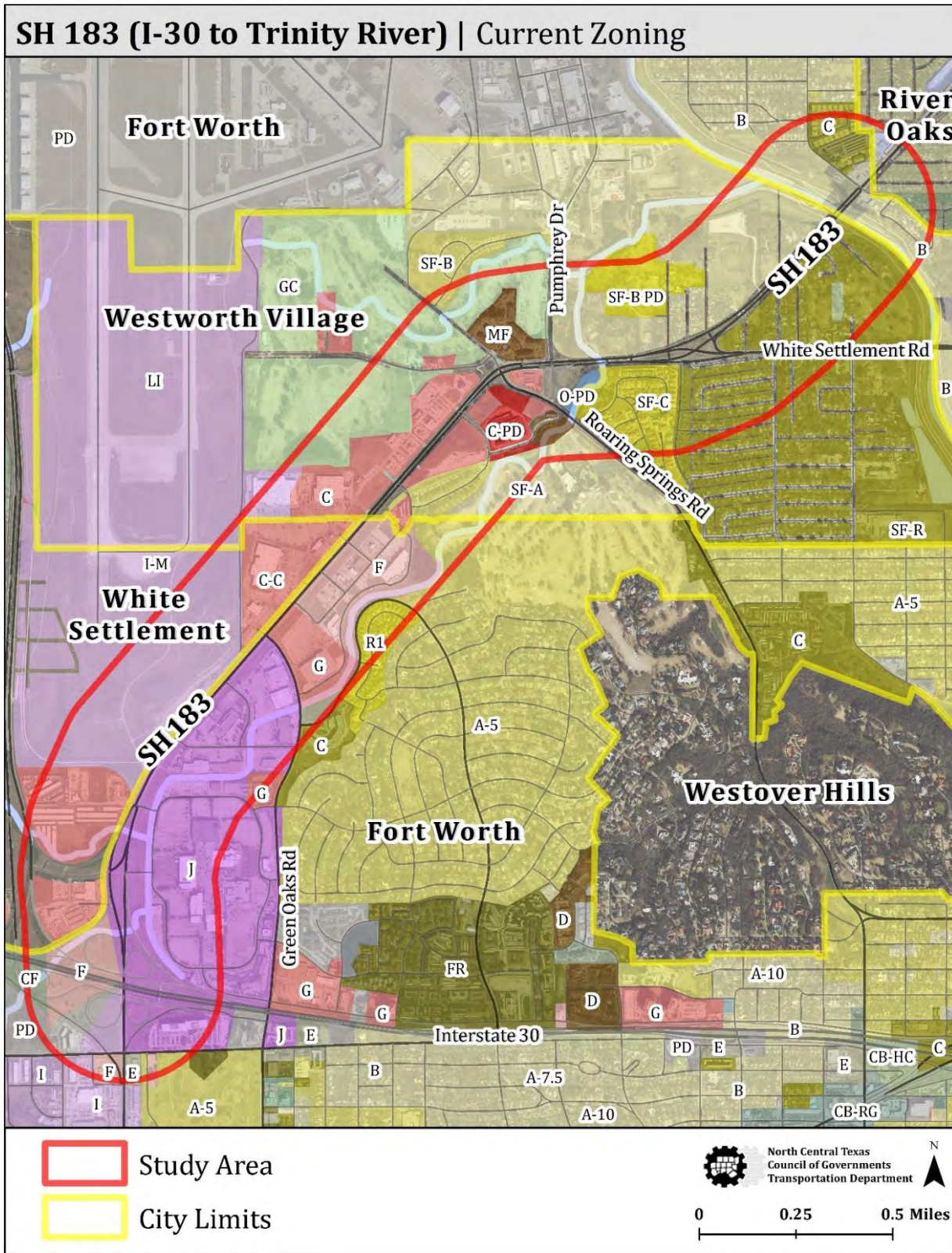
The central section of the study area between Green Oaks Road and Roaring Springs Road contains the border nexus between the three cities. While each city is coded differently, the primary general zoning categories are commercial and retail. The northern section of the corridor between Roaring Springs Road and the Trinity River is primarily residential, with multifamily and single family zoning categories.

EXHIBIT I-20 shows the current zoning within the corridor and consists of the following categories:

- Fort Worth
  - J – Medium Industrial
  - G – Intensive Commercial
  - F – General Commercial
  - R1 – Zero Lot Line/Cluster Residential
  - A5 – One-family Residential
- White Settlement
  - CC – Corridor Commercial
  - IM – Medium Industrial
- Westworth Village
  - C – Commercial

- GC – Golf Course
- SFA – Large Lot Single Family Residential
- MF – Multifamily
- CPD – Commercial Planned Development
- SFBPD – Single Family Residential with Planned Development
- SFC – Custom Single Family Residential
- OPD – Office Planned Development
- SFR – Single Family Redevelopment
- LI – Light Industrial

**EXHIBIT I-20: Current Zoning**



**TRANSPORTATION CONDITIONS**

**Existing Right-of-Way and Cross Section**

The study corridor consists of a variable right-of-way width from the southern end of the corridor at IH 30 to the northern end at the Trinity River. Generally, the Texas Department of Transportation’s (TxDOT) right-of-way along SH 183 in the study area is 160 feet. There is also an additional 50 feet of right-of-way running parallel to SH 183 from the IH 30 interchange up to Sherry Lane, with the exception of land adjacent to Ridgmar Mall owned by Mall property owners. This right-of-way is comprised of utilities and the former Bomber Spur railroad track. The number of driving lanes is consistent throughout the study corridor as a divided highway consisting of four 12 foot driving lanes, a 30-foot-wide median, and occasional turn lanes. EXHIBIT I-21 and EXHIBIT I-22 show the typical existing cross section for SH 183.

**EXHIBIT I-21: Existing Typical Right-of-Way (With Bomber Spur)**



**EXHIBIT I-22: Existing Typical Right-of-Way (Without Bomber Spur)**



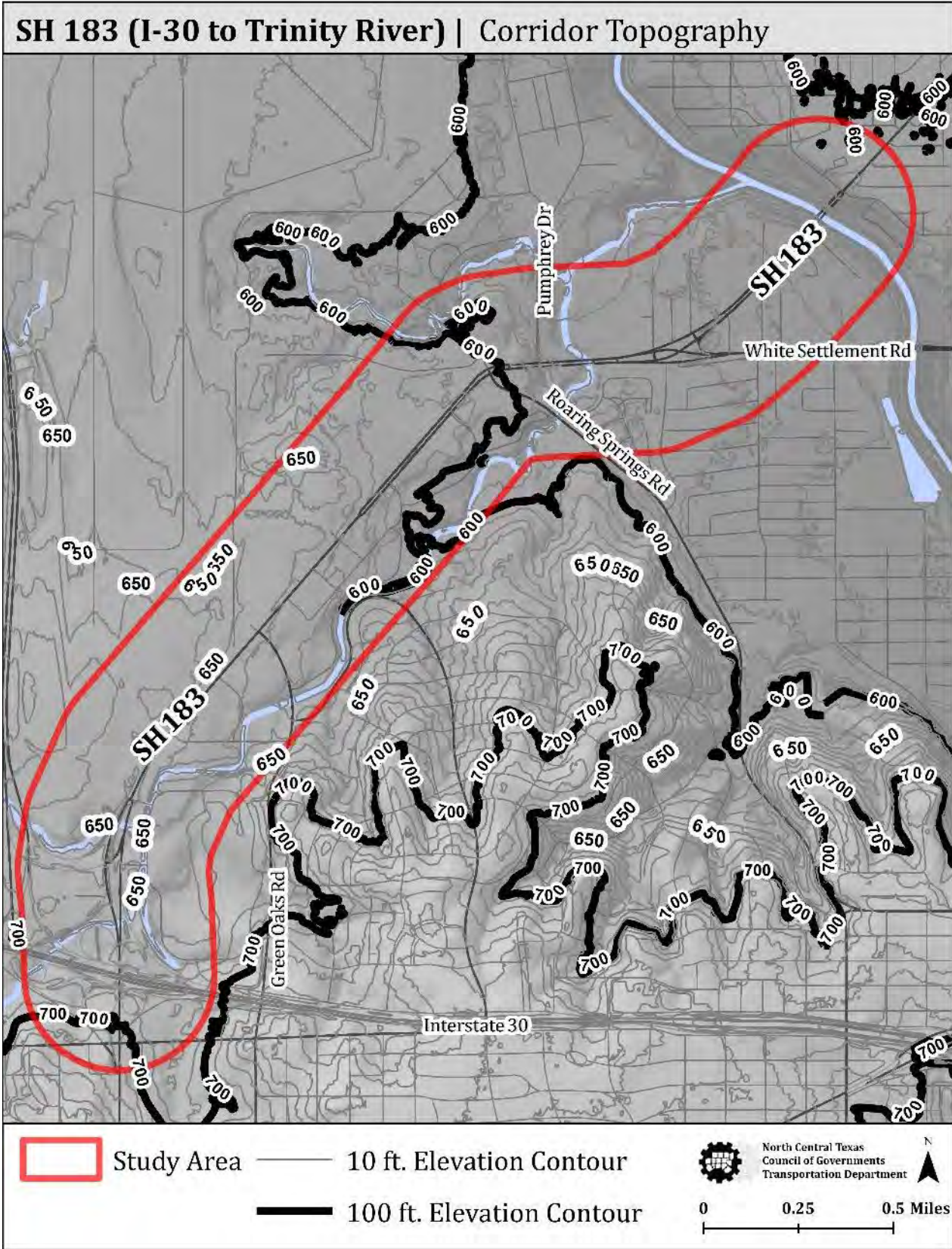
### **Additional 50 Feet of Right-of-Way along Part of SH 183**



#### **Topography**

Topography along the corridor is generally flat, with the highest elevation being 700 feet on the southern end and 600 feet lower on the northern end towards the Trinity River. The corridor gradually descends northward. The corridor avoids the steeper grades located just east of the project area in Fort Worth and Westover Hills. EXHIBIT I-23 illustrates the topography with contours spaced further apart representing a flatter terrain vs. closely clustered contours reflecting a steeper change in elevation.

**EXHIBIT I-23: Corridor Topography**



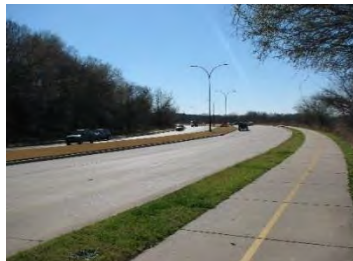
**Bicycle System**

The existing, funded and planned bikeway network in the corridor consists of both off-street and on-street facilities. Off-street facilities are composed of sidepaths, which are shared-use paths running parallel to a roadway that are located immediately adjacent to or offset from the roadway. On-street facilities provide accommodations for bicycles within the roadway cross section to allow for shared use with vehicles on the roadway. These include separated bike lanes, buffered bike lanes, conventional bike lanes and shared lane markings. Each of these bikeway facility types are referenced in the American Association of State Highway and Transportation Officials (AASHTO) Guide for the Development of Bicycle Facilities, National Association of City Transportation Officials' Urban Bikeway Design Guide and Federal Highway Administration's (FHWA) Separated Bike Lane Planning and Design Guide. EXHIBIT I-24 illustrates some examples of bicycle facility treatments.

**EXHIBIT I-24: Bicycle Facility Examples**



Off-Street:  
Shared-use Path (Trail)



Off-Street:  
Sidepath



On-Street:  
Separated Bike Lane



On-Street:  
Buffered Bike Lane



On-Street:  
Conventional Bike Lane



On-Street:  
Shared Lane Markings



EXHIBIT I-25 identifies existing, funded, and planned bicycle facilities within the study area. Fort Worth and Westworth Village are the only cities in the study area that have an adopted stand-alone bike plan (Bike Fort Worth and Westworth Village's Parks and Trails Plan) and reflect the existing, funded and planned network of off-street and on-street bicycle facilities. The Cities of River Oaks and White Settlement have planned bicycle facilities documented in their Comprehensive Vision Plans, which were developed as part of the NCTCOG Joint Land Use Study. The City of Fort Worth also proposed various on-street connection links to several communities in their plan. A Regional Veloweb path alignment is identified in these plans generally parallel to SH 183 in the corridor. The Regional Veloweb is the network of existing and planned off-street shared-use paths within the region that was adopted by the Regional Transportation Council as part of Mobility 2040. EXHIBIT I-26 represents a zoomed view of each of the key segments identified in the facilities map.

**Segment 1:**

Mobility 2040 reflects alignments identified from Westworth Village's Parks and Trails Plan. Their plan identifies a planned bike lane on SH 183 from the Trinity River to the entrance of retail shopping centers on SH 183 in Westworth Village.

**Segment 2:**

Beginning at the trailhead of Airfield Falls Conservation Park, a funded Veloweb path will travel south along Pumphrey Drive crossing the SH 183 interchange via a funded bicycle and pedestrian underpass. After crossing the interchange, the path will follow a westward utility corridor where it will end at the intersection of Sherry Lane and SH 183. This Veloweb path section was funded through the 2014 Transportation Alternatives Program call for projects. The project's improvements will include a pedestrian crossing and pedestrian signal at Sherry Lane and SH 183.

**Segment 3:**

South of Sherry Lane, the planned Veloweb path alignment continues along the east side of SH 183 crossing IH 30 and connecting with the planned Bomber Spur Regional Veloweb trail.

**Segment 4:**

A planned community shared-use path will provide a connection into White Settlement from the corridor. This planned path will need to cross SH 183 in a suitable location to safely connect with the planned community path along Lockheed Boulevard. The path is currently planned to continue north along Lockheed Boulevard where it will connect to Clifford Street via a railroad easement, then travel west on Clifford to the intersection at Bomber Road where the path will travel north along Bomber Road to Lake Worth.

**Segment 5:**

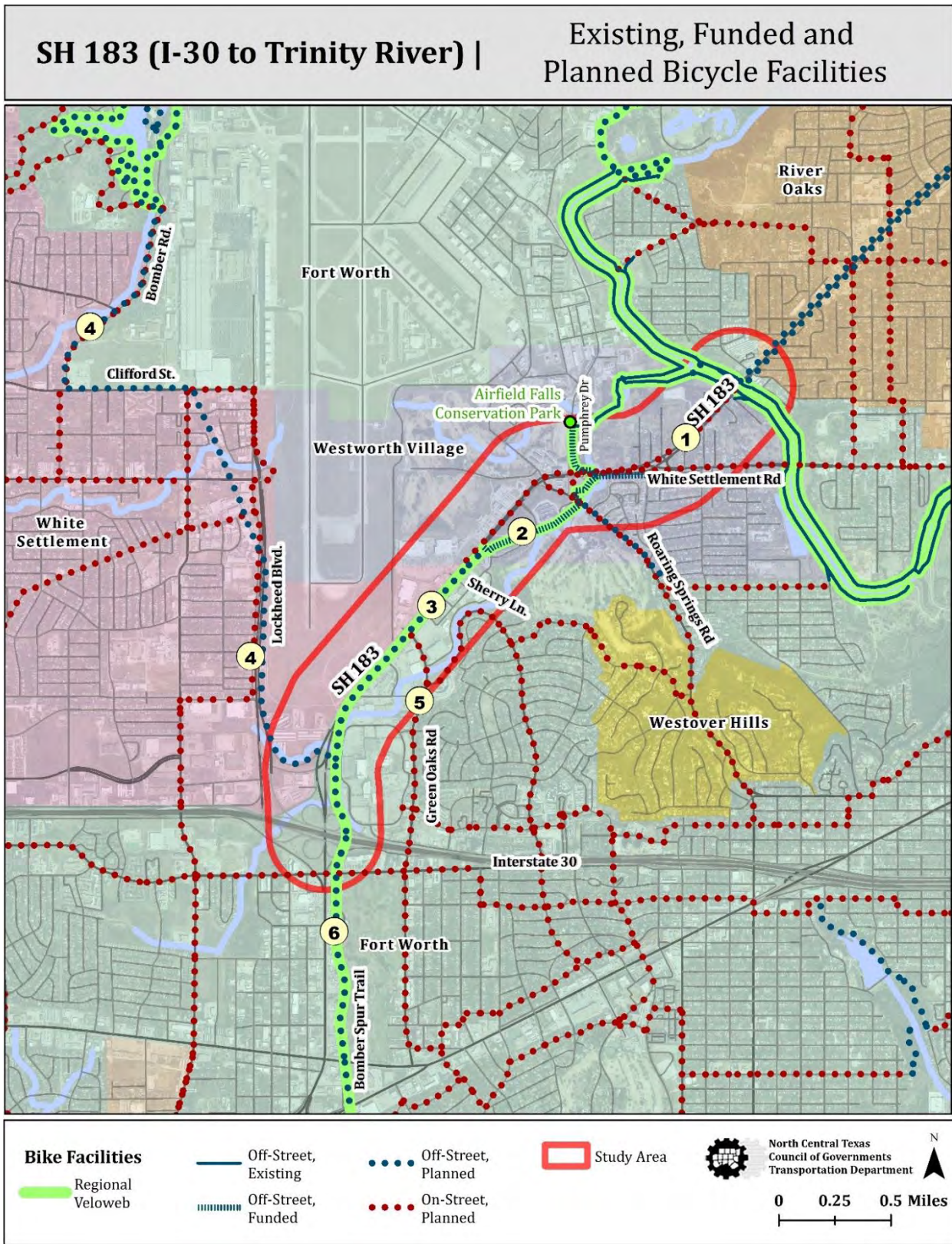
The City of Fort Worth identifies a planned bike lane on Green Oaks Road that will connect at the northern end to the planned Veloweb path alignment along SH 183.

**Segment 6:**

The IH 30 and SH 183 interchange will be included with the reconstruction of the IH 30 segment between IH 820 and Bryant Irvin Road. This reconstruction is included in the 10-Year Plan related to House Bill 20, which was adopted by the Regional Transportation Council in December 2016 and approved by the Texas Transportation Commission in February 2017. TxDOT has committed to include a pedestrian and bicycle crossing of IH 30 as part of the interchange reconstruction. The interchange has not yet been programmed for design, engineering and/or construction. The overall construction of the corridor has an expected total reconstruction cost of \$500 million with potentially \$150 million primarily focused on the IH 30/SH 183 interchange.

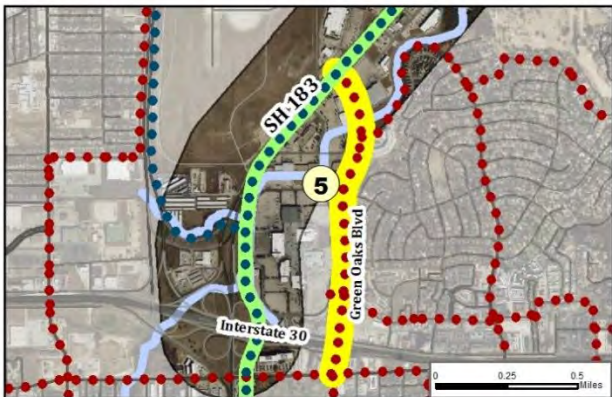
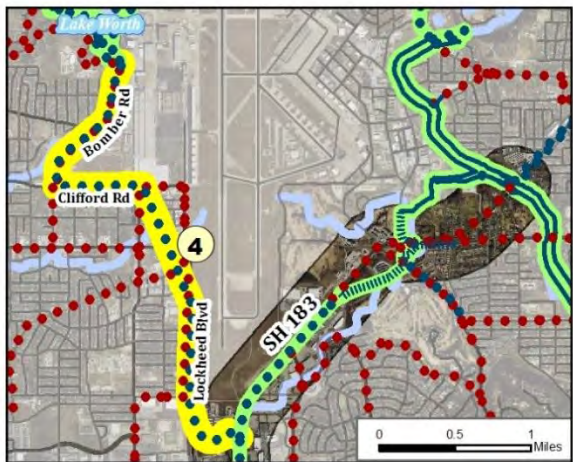
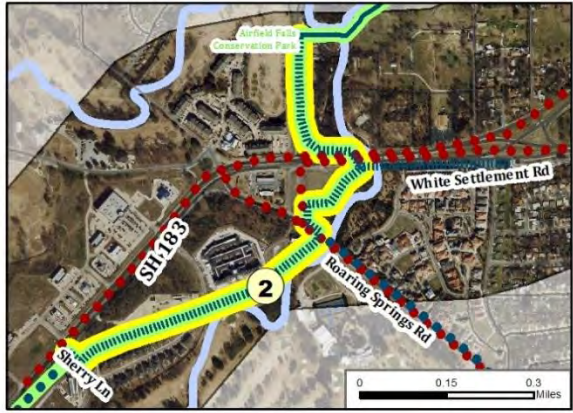
Currently the City of Fort Worth and Streams and Valleys Inc. are coordinating to secure funding for engineering and constructing of the Bomber Spur Regional Veloweb trail which will extend southbound to W. Vickery Boulevard and near Z Boaz Park.

**EXHIBIT I-25: Bicycle Facilities**



**EXHIBIT I-26: Highlighted Segments**

**SH 183 (I-30 to Trinity River)** **Highlighted Bikeway Segments**



<b>Bike Facilities</b>		Off-Street, Funded	<b>Highlighted Segment</b>			North Central Texas Council of Governments Transportation Department	
Regional Veloweb	Off-Street, Planned						
Off-Street, Existing	On-Street, Planned						

## **Pedestrian System**

The existing land uses and design of buildings could have affected the limited number of sidewalk and pedestrian facilities throughout the corridor. There are local sidewalks within the project area; however, no sidewalks currently exist within the SH 183 right-of-way between IH 30 and the Trinity River, as shown in EXHIBIT I-28. Green Oaks Road is the only intersecting street on SH 183 that has sidewalks near the intersection. However, the sidewalks end at the SH 183 right-of-way.

Fort Worth is the only city in the area with an adopted plan addressing pedestrian facilities (Walk Fort Worth). Included within the plan is the American Disabilities Act (ADA) Transition Plan. An ADA Transition Plan is required by law, according to Title II of the Americans with Disabilities Act of 1990. Under this title, states and local governments employing more than 50 people are required to develop a plan to schedule the removal of the barriers uncovered by the self-evaluation process. Fort Worth is the only city in the study area required to complete an ADA Transition Plan at this time.

The only crosswalk on SH 183 is at an intersection of a private driveway leading into Sam's Club and other nearby businesses; however, there are no connecting sidewalks at the intersection. This intersection and the intersection of SH 183 and White Settlement Road are the only intersections along the corridor that have pedestrian crossing signals and buttons. There are 59 driveway access points and street intersections, 10 of which are signalized.

### **Pedestrian Push Button at SH 183 and White Settlement Road**



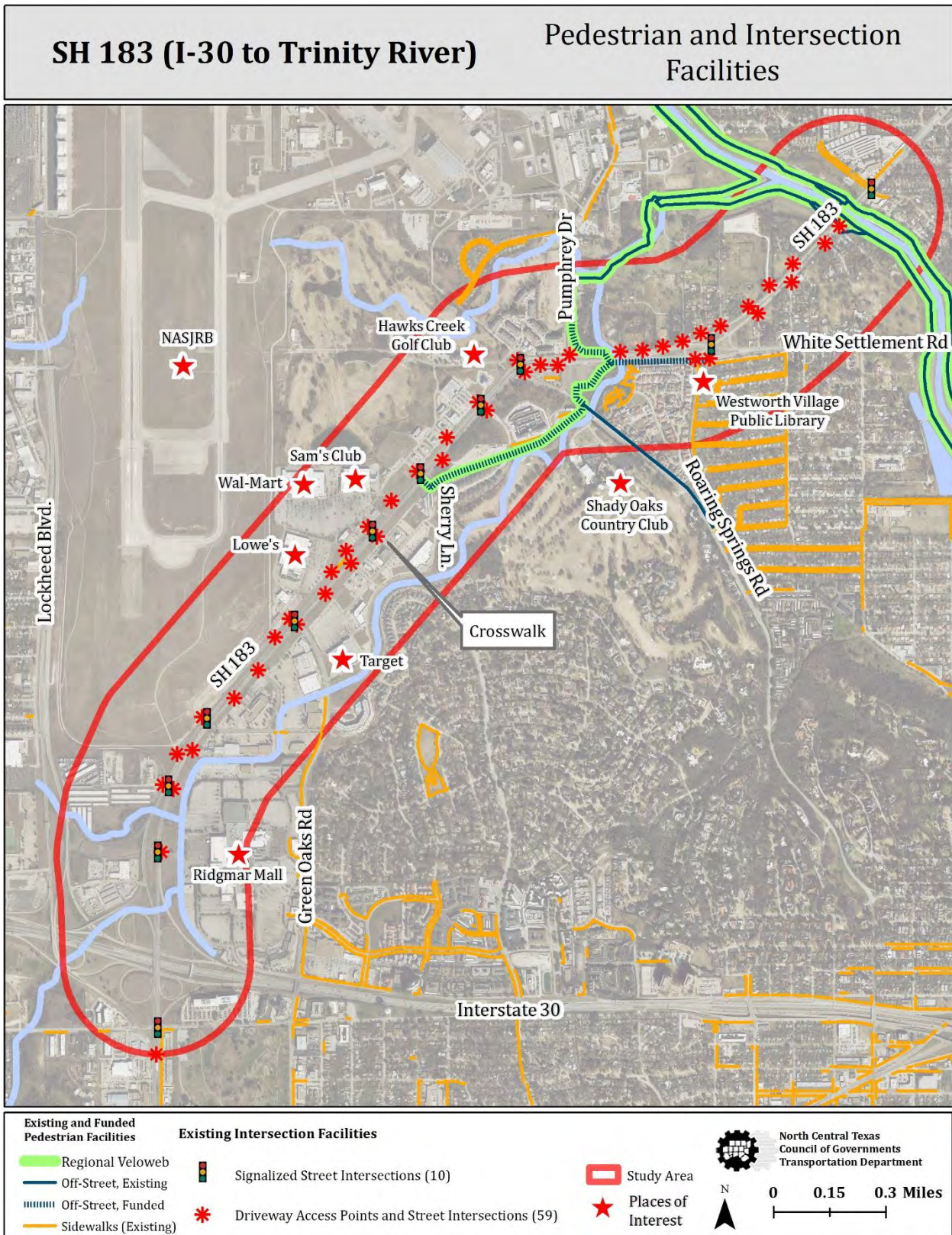
### **Traffic Signal Operations**

The traffic signals were retimed along SH 183 in 2008 through NCTCOG's Regional Traffic Signal Retiming Program. A total of 10 traffic signals were retimed. EXHIBIT I-27 shows a list of the intersections that were retimed during this effort within the study area. SH 183 intersections within the City of Fort Worth were retimed again by the City of Fort Worth from the Ridgmar Mall entrance to Roaring Springs Road in 2012. It is recommended these types of signals be retimed every four years. EXHIBIT I-28 shows signalized and non-signalized intersections along the corridor.

#### **EXHIBIT I-27: Retimed Signalized Intersections (2008/2012)**

<b>Intersection</b>	<b>City</b>	<b>Operations and Maintenance</b>	<b>Year of Retiming</b>
SH 183/White Settlement Road	Westworth Village	TxDOT Fort Worth	2008
SH 183/Roaring Springs Road	Westworth Village	TxDOT Fort Worth	2008
SH 183/Wal-Mart Entrance	Fort Worth	City of Fort Worth	2012
SH 183/Green Oaks Road	Fort Worth	City of Fort Worth	2012
SH 183/Ridgmar Meadow Road	Fort Worth	City of Fort Worth	2012
SH 183/Ridgmar Mall Entrance	Fort Worth	City of Fort Worth	2012

**EXHIBIT I-28: Pedestrian and Intersection Facilities**



## **Transit System**

Fixed-route transit service, defined as a system operating on a prescribed route with a fixed schedule, began operating on the SH 183 corridor as the River Oaks Crosstown Bus service in April 2017 by the FWTA. The service has a southern terminus at the Ridgmar Mall Transit Center and a northern terminus at the City of Fort Worth's Historic Stockyards, which has two stops along the corridor as shown in EXHIBIT I-29.

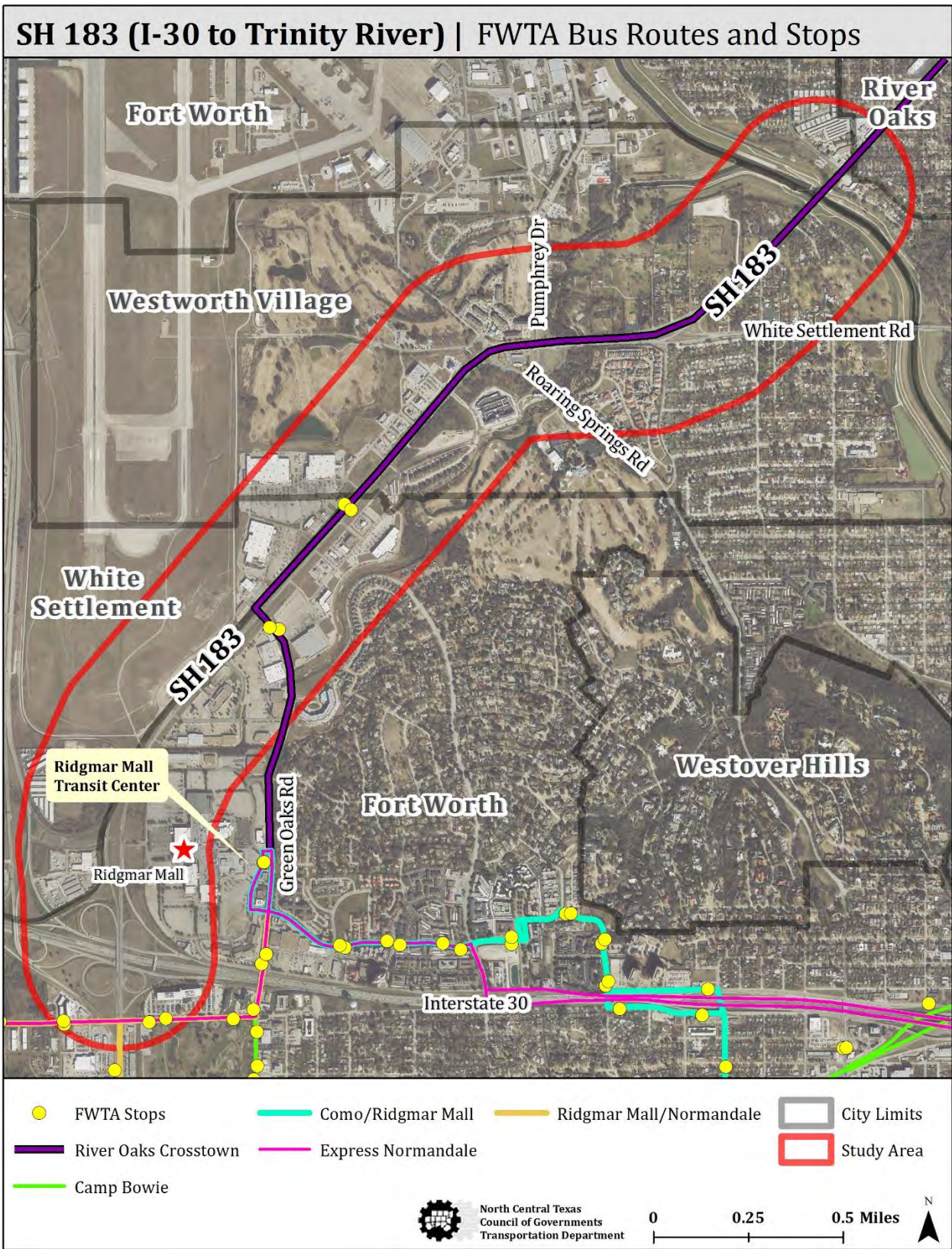
The City of River Oaks City Council approved a resolution in February 2017 supporting bus transit service through the City. Officials with the NAS Fort Worth JRB have shown interest in transit along the corridor to help relieve vehicular traffic congestion in and out of the Pumphrey Drive base entrance.

Existing service in the study area is offered at Ridgmar Mall and served by FWTA bus routes 2 (Camp Bowie), 26 (Ridgmar Mall/Normandale), 27 (Como/Ridgmar Mall), and 61 (Express Normandale), as shown in EXHIBIT I-29. Specialized transit providers who operate demand-response service in this area include Tarrant County Transportation Services, Catholic Charities Transportation Services, Senior Citizens Services of Greater Tarrant County and Mobility Impaired Transit Services (MITS) of FWTA.

EXHIBIT I-30 and EXHIBIT I-31 show the number of transit trips beginning and ending within the study area and uses data from the 2014 Regional On-Board Transit Survey. This survey asked transit riders about their daily trips. The survey data indicates that a small number of individuals are using fixed-route transit service for any trip purpose from FWTA, with the highest concentration at the southern end of the corridor. The survey estimated that over 1,000 daily transit trips are made to the Ridgmar Mall Transit Center. The transit center is located on the west side of Green Oaks Road just north of Plaza Parkway and is served by an adjacent park-and-ride lot.



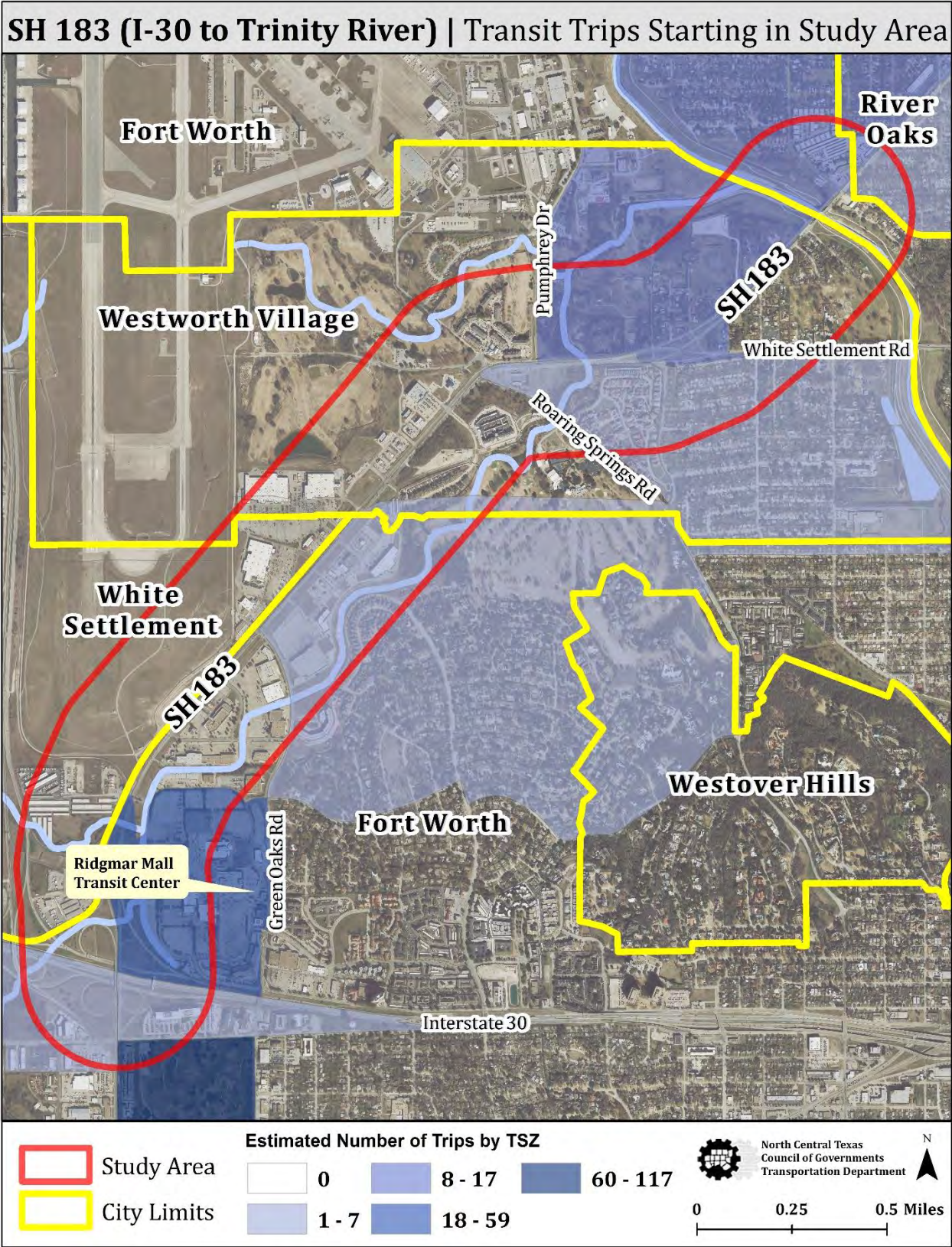
**EXHIBIT I-29: FWTA Bus Routes and Stops**



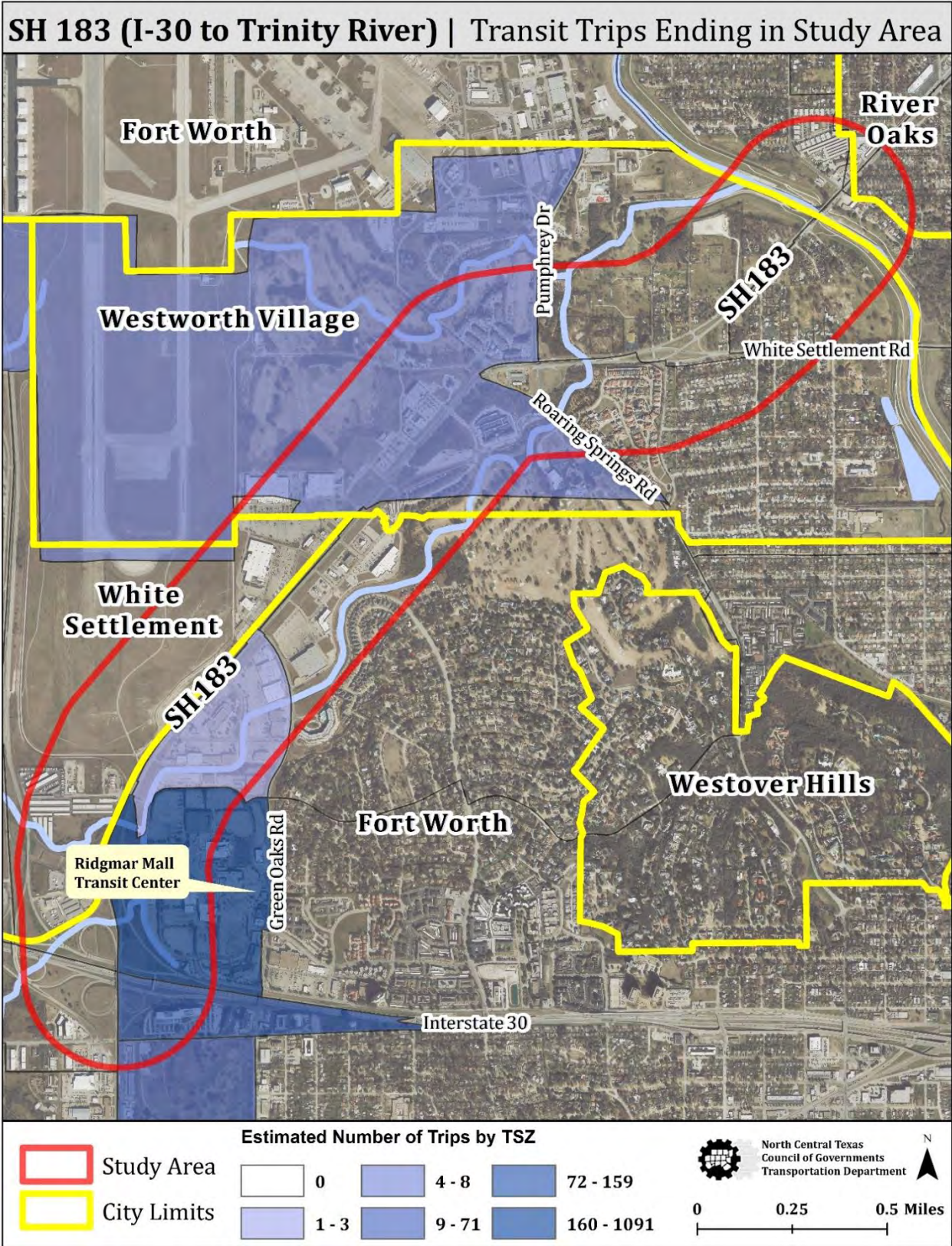
**Ridgmar Mall Transit Center**



**EXHIBIT I-30: Transit Trips Origin by TSZ**



**EXHIBIT I-31: Transit Trips Destination by TSZ**



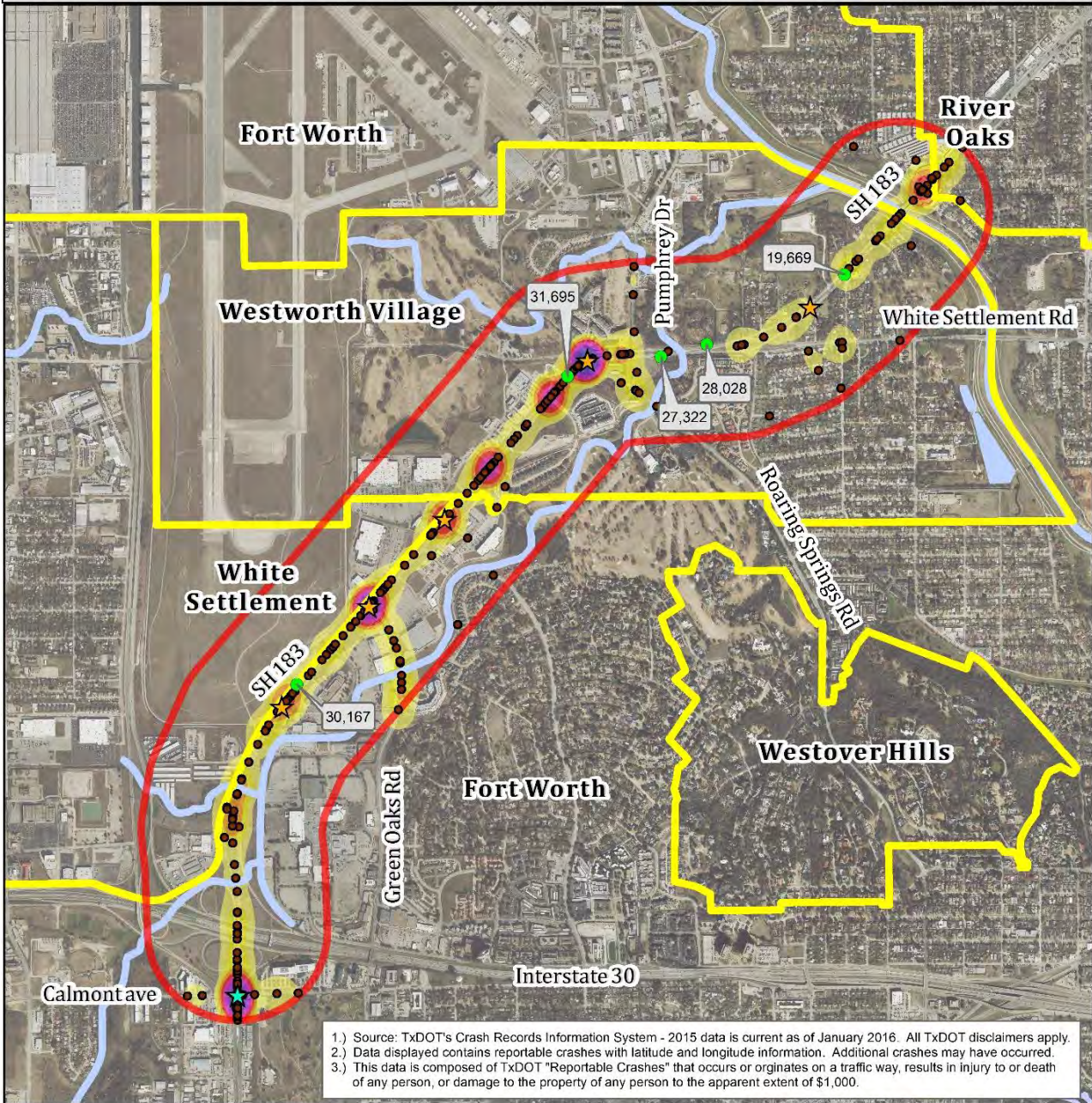
**Automobile, Bicycle, and Pedestrian Crashes and Traffic Volumes**

The Texas Department of Transportation's Crash Reports Information System (CRIS) dataset was used to identify the crash locations and severity for crashes on and around the SH 183 corridor between the years of 2011 and 2015. There were 452 auto crashes in the study area within this period. Based on the crash density analysis displayed in EXHIBIT I-32, there are eight street and driveway intersections along SH 183 that have higher concentrations of auto crashes. There was one fatality in an automobile crash during the five-year period that occurred at the intersection of SH 183 and Calmont Avenue, near the area of the SH 183 and IH 30 interchange.

The intersection at Roaring Springs Road and SH 183 in the northern half of the study area has both the highest number of crashes and the highest daily traffic volume (31,695 vehicles per day) in the study area. Daily traffic counts were available from TxDOT from the year 2014 for six locations along the corridor. The daily traffic count decreases significantly in the northern part of the corridor at 19,669 vehicles per day. A potential cause for this reduction in volumes is that Roaring Springs Road serves as a major thoroughfare for the neighborhood on the east side of SH 183 and also serves as the main entrance to the NAS Fort Worth JRB. EXHIBIT I-33 summarizes the crash information in the study area from the years 2011 to 2015, which includes motor vehicle, bicycle and pedestrian crashes. The crashes are sorted by severity ranging from "Non-Injury Crashes" to "Fatal."

**EXHIBIT I-32: Crash Density and Traffic Volumes**

**SH 183 (I-30 to Trinity River) | Crash Density and Traffic Volumes**



1.) Source: TxDOT's Crash Records Information System - 2015 data is current as of January 2016. All TxDOT disclaimers apply.  
 2.) Data displayed contains reportable crashes with latitude and longitude information. Additional crashes may have occurred.  
 3.) This data is composed of TxDOT "Reportable Crashes" that occurs or originates on a traffic way, results in injury to or death of any person, or damage to the property of any person to the apparent extent of \$1,000.

**Crash Density**

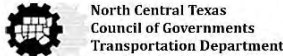
Low Crash Density Medium Crash Density High Crash Density Very High Crash Density

Vehicle Fatality (1) Traffic Volume Count Location (2014)

Vehicle Crashes (452) Study Area

Bicycle and Pedestrian Crashes (6) City Limits

0 0.25 0.5 Miles



**EXHIBIT I-33: SH 183 Corridor Crashes (Source: TxDOT CRIS 2011-2015)**

	2011	2012	2013	2014	2015	Total
<b>Total Crashes (Auto)</b>	<b>71</b>	<b>104</b>	<b>97</b>	<b>91</b>	<b>95</b>	<b>458</b>
Non-Injury Crashes	30	43	56	45	62	<b>236</b>
Possible Injury Crashes	16	35	24	25	20	<b>120</b>
Unknown Injury Crashes	1	5	0	2	0	<b>8</b>
Non-Incapacitating Crashes	17	13	11	15	10	<b>66</b>
Incapacitating Injury Crashes	7	6	3	4	1	<b>21</b>
Fatal Crashes	0	1	0	0	0	<b>1</b>
<b>Total Crashes (Bike/Ped)</b>	<b>0</b>	<b>1</b>	<b>3</b>	<b>0</b>	<b>2</b>	<b>6</b>
Non-Injury Crashes	0	0	0	0	0	<b>0</b>
Possible Injury Crashes	0	1	2	0	1	<b>4</b>
Unknown Injury Crashes	0	0	0	0	0	<b>0</b>
Non-Incapacitating Crashes	0	0	0	0	0	<b>0</b>
Incapacitating Injury Crashes	0	0	1	0	1	<b>2</b>
Fatal Crashes	0	0	0	0	0	<b>0</b>

**PUBLIC AND STAKEHOLDER VISION****Public Involvement****Technical Working Group Meetings**

A Technical Working Group (TWG) was established early in the planning process to help guide the corridor master plan's goals and recommendations. NCTCOG staff members reached out to key partner agencies to form the TWG. These key partner agencies included:

- City of Fort Worth
- City of Westworth Village

- City of White Settlement
- Tarrant County
- West Tarrant Alliance
- Fort Worth Transportation Authority
- Texas Department of Transportation
- Naval Air Station Joint Reserve Base Fort Worth

The Technical Working Group maintained constant communication throughout the planning process and held two meetings. The first meeting, held on March 15, 2017, acted as a kick-off for the TWG participants. Discussion items included the previous planning efforts in the area, study area boundary, existing right-of-way, existing conditions data collection, potential for transit on the corridor, and the overall project schedule. TWG representatives commented that the corridor vision should include improved walkability with better access to businesses and the Trinity River trails, maximizing greenery and landscaping along the corridor, and should include context-sensitive streetscape zones. Corridor strengths were identified as follows: availability of right-of-way, NAS Fort Worth JRB weekend events, and potential for a “catalyst” type of redevelopment located at Ridgmar Mall.

The second TWG meeting was held on August 15, 2017. Discussion items included the recommended design options for the streetscapes and key intersections in each of the context zones, and the project schedule and next steps. TWG members provided feedback on each of the recommended design options, as well as a design concept for the IH 30/SH 183 interchange.

### **Community Meetings**

The first community meeting was held on April 20, 2017 at the Westworth Village Municipal Complex. The intention of this community meeting was to introduce the project to the community, present existing conditions, conduct a visual preference survey, develop a vision statement through a visioning exercise, and gather input for initial preliminary streetscape and intersection design concepts developed by NCTCOG staff and the TWG representatives.



An initial presentation discussed the project background, purpose, schedule, and existing conditions along the corridor. Stations staffed by NCTCOG were set up for existing conditions, visioning, and preliminary streetscape and key intersection design options for each of the three context zones along the corridor. Members of the community were able to provide comments and ask questions at all of the stations.

The visual preference survey gauged attendees' preferences in pedestrian and bicycle facilities, pedestrian and bicycle bridges, landscaping, lighting, bus shelters, and other pedestrian amenities. Approximately 33 people participated in the visual preference survey. The results of this survey are detailed in the following section.

### **NCTCOG Staff Answer Questions during the First Public Meeting**



Two additional community meetings were held to present recommended design options for the streetscapes and key intersections in each of the context zones. The second meeting was held September 14, 2017 at the Westworth Village Municipal Complex. The third was held September 21, 2017 at SplashDayz Waterpark and Conference Center in White Settlement. An initial presentation discussed the project background, purpose, and schedule; existing conditions; recommended design options for streetscapes and key intersections in each of the context zones; and a design concept for the IH 30/SH 183 interchange. Several stations staffed by NCTCOG were set up for existing conditions and recommended design options in each of

the three context zones along the corridor. Members of the community were able to provide comments and ask questions at all of the stations.

Community meeting summaries can be found in Appendix A.

## **Visual Preference Survey**

### Overview and Methodology

A visual preference survey was conducted at the first community meeting on April 20, 2017. A visual preference survey is a visualization technique that helps citizens and decision-makers to determine preference for various types of streetscape, community design, and built environment options. Participants are shown a series of photographic images and asked, in the case of this survey, to select their preferred image that contributes to the community's overall vision. By using images rather than words, visualizations techniques such as this allow for a "common language" for both technical and non-technical participants, helping to guide participants through the visioning process while educating them on potential development alternatives.

Care should be taken when prescribing recommendations based on a visual preference survey, as respondents are rating the images based on the attractiveness of the image, without necessarily thinking of the fiscal or regulatory trade-offs. Nevertheless, the findings from the visual survey should help inform the overall vision and image for the corridor.

### Survey Results


The results provided key community input regarding their vision for the corridor. Below is a general summary of the community's vision by category and the top preferred images for each category. The percentages of respondents selecting each preferred image are shown in EXHIBIT I-34.







- Pedestrian and Bicycle Facilities
  - Wide, winding sidewalks and shared-use paths that are set back from the auto travel lanes and are shaded by large trees are preferred.





- Respondents also preferred crosswalks that feature brick pavers or other non-conventional designs with decorative paving patterns.
- Pedestrian and Bicycle Bridges
  - For bridges over highways, respondents preferred a modern structure that could potentially incorporate more traditional design elements.
  - Pedestrian and bicycle trail bridges that featured classic, traditional stone and wood design received the highest response.
- Landscaping, Lighting, and Other Pedestrian Amenities
  - Grass, trees, and xeriscaping were preferred for sidewalk-adjacent landscaping, while more ornate, formal landscaping received the highest responses for medians.
  - Ornate tree-branch lighting is preferred to illuminate sidewalks and the roadway.
  - Pedestrian amenities that are arranged in mini-plaza settings were preferred.
- Bus Shelters
  - Covered bus shelters featuring wooden overhang in a non-conventional design or standard black metal were preferred.

The full Visual Preference Survey tool and results are included in Appendix B.

**EXHIBIT I-34: Top Scoring Images from the Visual Preference Survey**

Type	Image	Percent Selected as Preference
Pedestrian Facilities		63%

Type	Image	Percent Selected as Preference
Bicycle Facilities		63%
Pedestrian Street Crossings		64%
Bicycle/Pedestrian Bridges (Over Highway)		33% (each)
Bicycle/Pedestrian Bridges (Over River)		33% (each)
Landscaping		36% (each)
Median Landscaping		58%

Type	Image	Percent Selected as Preference
Lighting		33%
Pedestrian Amenities		47%
Bus Stop Amenities		81%
Bus Shelter Design		39%

## **II. CORRIDOR RECOMMENDATIONS**

### **SUMMARY OF RECOMMENDATIONS**

These recommendations do not comprise a detailed engineering proposal. Rather, the goal of the recommendations is to provide context-sensitive building blocks and conceptual designs for improving transportation options, mobility, and community character along the corridor. These recommendations are also intended to provide a guide to TxDOT to use for the plans, specifications, and engineering (PS&E) and environmental review of the corridor. Improvements to the corridor are broken out into three distinct context-sensitive zones, defined by the primary land uses along the corridor and the available right-of-way, as shown in EXHIBIT II-1. All of these concepts will require detailed traffic studies to further refine the concepts and costs during the environmental and engineering phases of the SH 183 reconstruction project. To reduce travel delays at the signalized intersections along the corridor, future upgrades should be made to the traffic signals to provide for coordinated signal timing.

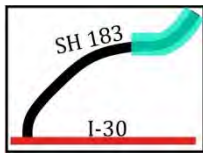
### **Corridor-wide Improvements**

EXHIBIT II-1 illustrates the three context zones and key areas throughout the corridor. Improvements to all sections of the corridor include a sidewalk on the northwest side of the roadway, a bicycle and pedestrian shared-use path that is set back from the roadway on the southeast side, landscaping, and pedestrian amenities such as lighting and wayfinding. A shared-use path is the preferred bicycle and pedestrian accommodation throughout the corridor. TxDOT requires a minimum 14-foot outside lane, where on-street paved shoulders or bicycle lanes are required. These are included in the recommendations, but practical application has shown that users are much more likely to use the off-street shared-use path.

To the extent possible, the landscaping, pedestrian facilities, and pedestrian amenities should be guided by the preferences of the community identified in the visual preference survey, summarized in EXHIBIT I-34. The specific recommendations for each street cross section are detailed in the following sections.

Finally, one of the primary functions of the SH 183 corridor is to move traffic from the NAS Fort Worth JRB, and the surrounding communities in the area to and from IH 30. To reduce travel delays at the signalized intersections along the corridor, recommendations include implementing coordinated (progressed) systems controlled from a master controller and set up so lights "cascade" (progress) in sequence.

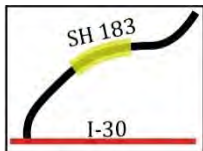
**River Access Context Zone**



The River Access Context Zone includes the northernmost portion of the study corridor, and extends from the Trinity River to just east of Pumphrey Drive.

This context zone is characterized by primarily residential land uses and access to the Trinity River trails. SH 183 through this section has a right-of-way width of 160 feet. Improvements for this context zone include a bicycle and pedestrian shared-use path, sidewalk, improved bicycle and pedestrian access across the Trinity River and to the Trinity River Trails, and a simplified configuration for the intersection of SH 183 and White Settlement Road.

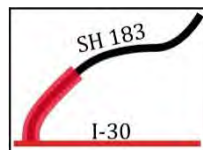
**Base Context Zone**



The Base Context Zone generally spans the middle portion of the study corridor from Pumphrey Drive to Sherry Lane, and is characterized by access to NAS Fort Worth JRB at Pumphrey Drive, multi-family and commercial land uses, and a SH 183 right-of-way width of 160 feet.

Improvements in this context zone include widening SH 183 from four to six lanes to accommodate existing and future traffic demands; a sidewalk and shared-use path along SH 183; aligning Roaring Springs Road with Pumphrey Drive; and reconstructing the interchange of SH 183 and Pumphrey Drive as an at-grade intersection.

**Commerce Context Zone**

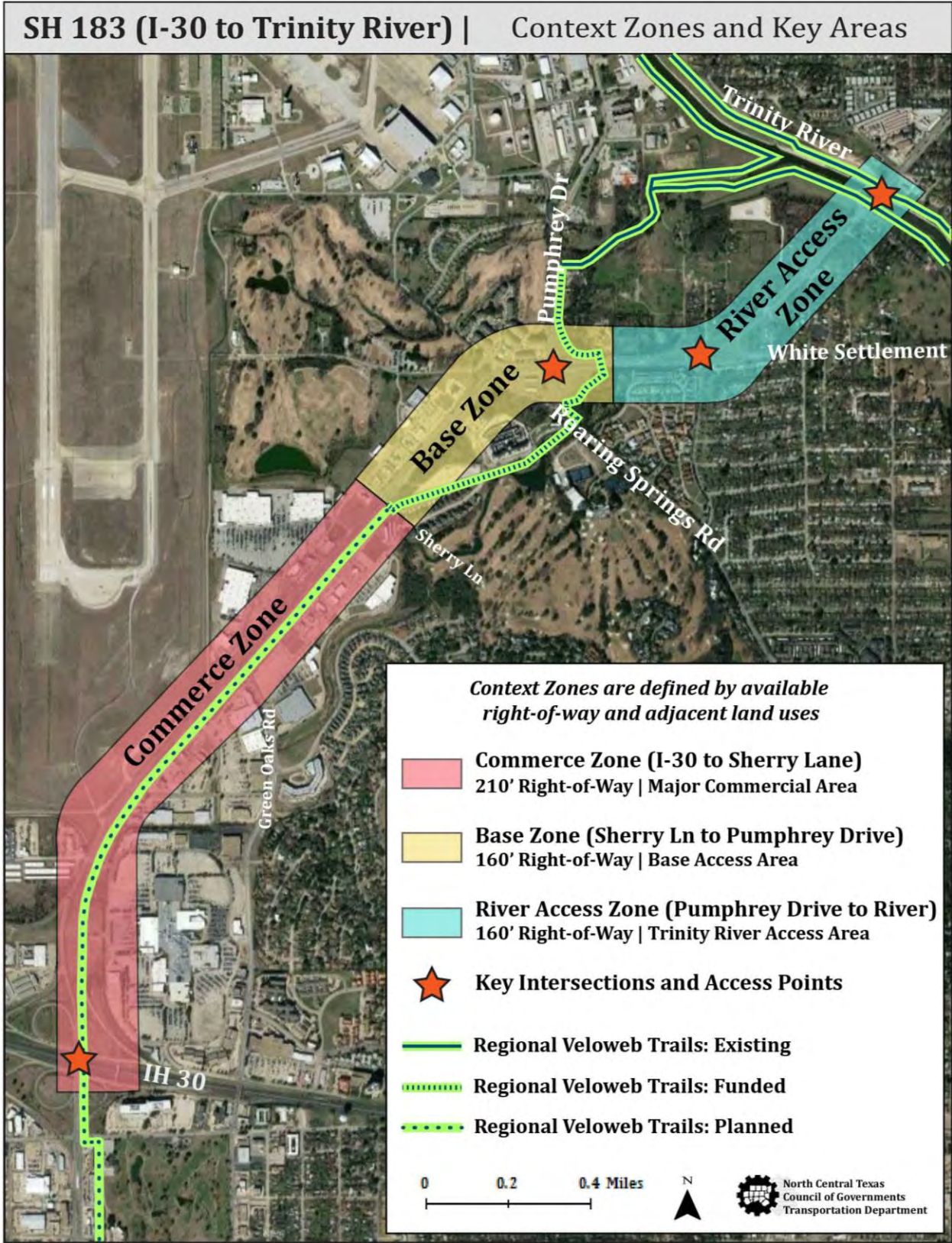


The Commerce Context Zone covers the southwest portion of the study corridor from Sherry Lane to the interchange of SH 183 and IH 30. It is

characterized by a right-of-way width of 210 feet, primarily commercial land uses and access to the Ridgmar Mall. Improvements in this context zone include widening SH 183 from four to six lanes, shifting the roadway to the west side of the right-of-way and creating a linear park or greenway with a shared-use path (Bomber Spur trail) in the excess right-of-way on the east side of the roadway. Improvements also include additional landscaping and vegetation to beautify the corridor.



**EXHIBIT II-1: Context Zones and Key Areas**



## **Overall Bicycle and Pedestrian Safety Countermeasures**

The SH 183 corridor should place priority for ensuring the level of comfort and safety of all non-motorized users of all ages and abilities. To accomplish an inclusive design approach, safety treatments and strategies should be implemented, including those outlined by FHWA's Proven Safety Countermeasures initiative (<https://safety.fhwa.dot.gov/provencountermeasures/>).

This list of Proven Safety Countermeasures treatments and strategies can address roadway departure and intersection issues, as well as pedestrian and bicycle crashes. Among the countermeasures are several crosscutting strategies that address multiple safety focus areas.

Street and driveway intersections are the most common location of crashes between motorists and vulnerable street users. The design of improvements in the SH 183 corridor should address and integrate the following, which are highlighted in more detail in Appendix C:

- Signage and Pavement Markings
- Protected Left Turns
- Accessible Pedestrian Signals
- Bicycle Signals, Detection and Actuation
- Directional (Perpendicular) Curb Ramps
- Modified Turn Lane Geometry
- Recessed Crossings
- Median Refuges and Shorter Crossing Distances
- Lighting

Every location where a vehicle can enter or leave SH 183 creates a potential conflict with through-moving motorists as well as people walking and bicycling, and represents a prospect for a crash to occur. For vulnerable road users, including pedestrians and bicyclists, these crashes can be particularly severe and even fatal. Appendix C outlines various techniques for access management for bicycle and pedestrian safety, including the following which should be integrated into future improvements:

- Geometry and Visibility Enhancements
- Pedestrian Markings and Signage
- Signage for Motorists Exiting Driveways and Cross Streets
- Signage for Motorists Entering Driveways and Cross Streets
- Signage for Pedestrians and Bicyclists on the Share-Use Paths
- Raised Crossings and Recessed Crossings

Since the Bomber Spur Trail along SH 183 is a Regional Veloweb connection to the Trinity River Trails, it is anticipated that it will experience high volumes of users. As such, various options should be integrated to mark the shared-use path for bicycle and pedestrian users. Under the Texas Manual on Uniform Traffic Control Devices (TMUTCD), a solid yellow line may be used to separate the two directions of travel on a shared-use path where passing is not permitted, and a broken yellow line may be used where passing is permitted.

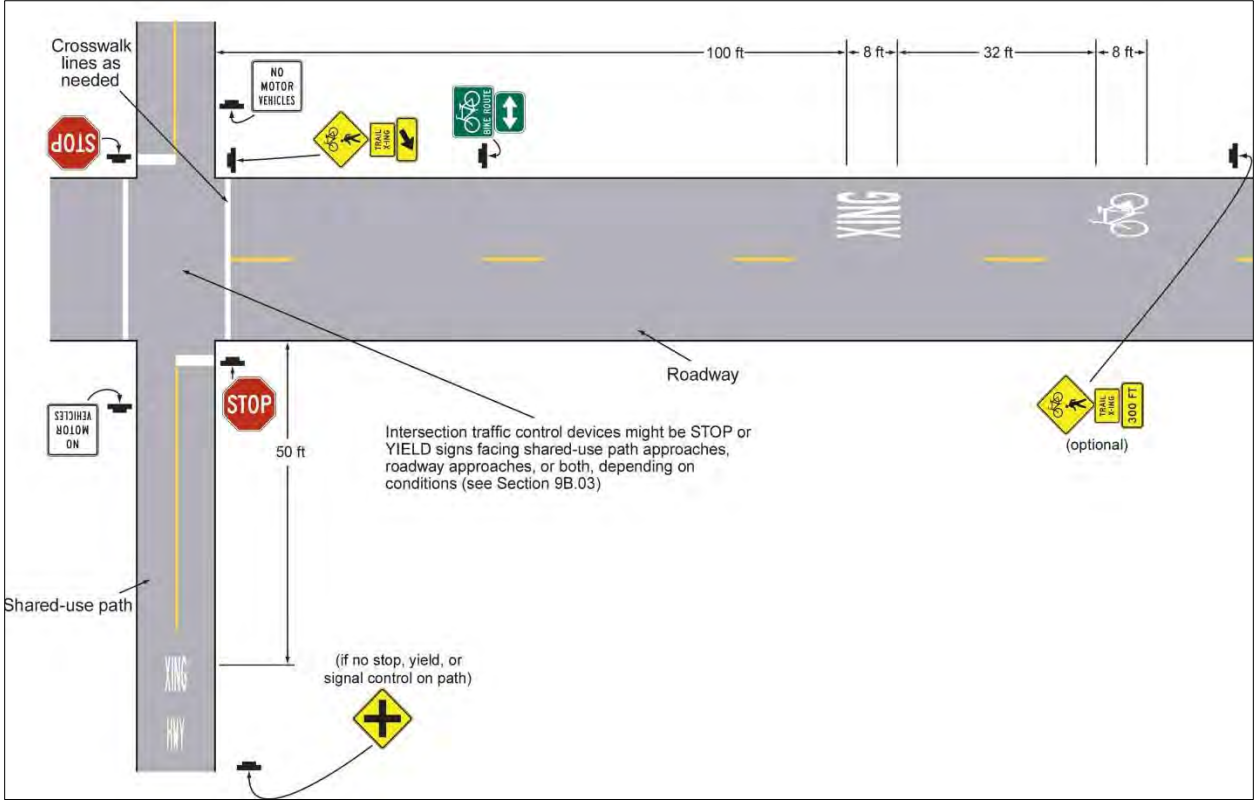
Alternatively, a solid white line may be used to separate different types of users on the path. The American Association of State Highway and Transportation Officials (AASHTO) recommends a bi-directional walking lane for pedestrians (at least 5 feet wide) with directional lanes of travel for cyclists (at least 10 feet wide). Users should be separated in areas with “extremely heavy pathway volumes.” In lieu of pavement markings, this separation of users can be accomplished by pavement treatments, landscaping, or separating users on dual pathways as illustrated in EXHIBIT II-2.

**EXHIBIT II-2: Example of Pavement Treatments for Separating Users on Dual Pathways**

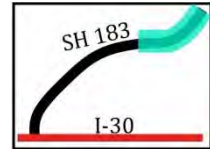


Careful consideration should be given to the safe accommodation of trail users at intersections and driveway crossings. EXHIBIT II-3 provides an example of signing and markings for a mid-block intersection of a shared-use path and a roadway, adapted from the 2011 TMUTCD.

**EXHIBIT II-3: Example of Mid-Block Path-Roadway Crossing**



## RIVER ACCESS ZONE



### Recommended Streetscape Design Option

The existing and proposed street cross sections are illustrated in EXHIBIT II-4. The River Access Context Zone includes the northernmost portion of the study corridor, and extends from the Trinity River to just east of Pumphrey Drive. SH 183 through this section has a right-of-way width of 160 feet, four travel lanes, and no existing sidewalks or other pedestrian facilities. At the north end of the study corridor, SH 183 crosses over the Trinity River on a four-lane bridge that was constructed in 1993, and which will likely not be due for reconstruction until 2040. The River Access Zone has the lowest 2040 projected traffic volumes in the study corridor.

Improvements in the River Access Context Zone are intended to provide more mobility options and improve access to the Trinity River Trails for people traveling by all modes of transportation. It is recommended that SH 183 through the River Access Zone remain a four-lane roadway, consistent with the existing and recommended roadway configuration to the north of the study corridor in River Oaks, and with the existing four-lane bridge over the Trinity River. Where there is sufficient right-of-way and conducive driveway spacing, a slip lane with angled parking is recommended on the northwest side of the roadway to improve community access to the Trinity River Trails, and in accordance with a desire for trail access parking expressed by the community at the first public meeting. The specific location of the slip lane should be a consideration during the environmental and engineering stages of SH 183 reconstruction.

Additional improvements in this zone include a sidewalk on the northwest side and a shared-use path on the southeast side. The shared-use path would connect with the existing, planned, or funded trails along the Trinity River to ultimately create one of the longest bicycle and pedestrian trails in the region – more than 50 miles long (previously illustrated in

EXHIBIT I-4). Median and trail-adjacent landscaping, roadway and pedestrian-scaled lighting, and other pedestrian amenities should be guided by the community preferences identified in the visual preference survey (previously illustrated in EXHIBIT I-34).

This streetscape concept is supported by the Westworth Village Parks and Trails Plan, which identifies a planned bicycle lane on SH 183 from the Trinity River to the entrance of retail shopping centers on SH 183 in Westworth Village.

### **Trinity River Access**

The existing access to the Trinity River and the recommended design option are illustrated in EXHIBIT II-5 and EXHIBIT II-6. Currently, the Trinity River Trail system passes beneath the SH 183 bridge with no formal way of allowing its users to connect to SH 183. There are informal unpaved paths that pedestrians may use; however, these could prove to be unsafe, especially in wet conditions. In addition, there is no way for trail users to access the other side of the river without using either the SH 183 bridge or an existing low water crossing which is inaccessible during high rains. Also, there are no sidewalks on either side of SH 183 or on the bridge. Pedestrians must walk in the space between the back of the curb and the property line, which contain obstacles such as holes and overgrown vegetation. Pedestrian and bicyclists crossing the bridge must use the 6-foot shoulder, which has no protection from moving vehicles.

The recommended concept is illustrated in EXHIBIT II-6. This design would facilitate non-motorized crossings over the river by installing a bridge at approximately the elevation of the trail that is configured to allow for pedestrian and bicyclist usage. Access from the trail to SH 183 would be by way of a paved path on the southeast side of the river, which would connect to Sky Acres Drive. A new sidewalk along the north side of SH 183 and a paved shared-use path on the south side would be provided. Pedestrians and bicyclists would use the 6-foot-wide shoulder on the existing SH 183 bridge to cross the Trinity River; however, concrete barriers would be provided for protection from vehicles. When the bridge is eventually reconstructed, it should be built with a sidewalk on the north side and a shared-use path on the south side of SH 183, both protected from traffic by a barrier. Wayfinding and crosswalks would be provided at

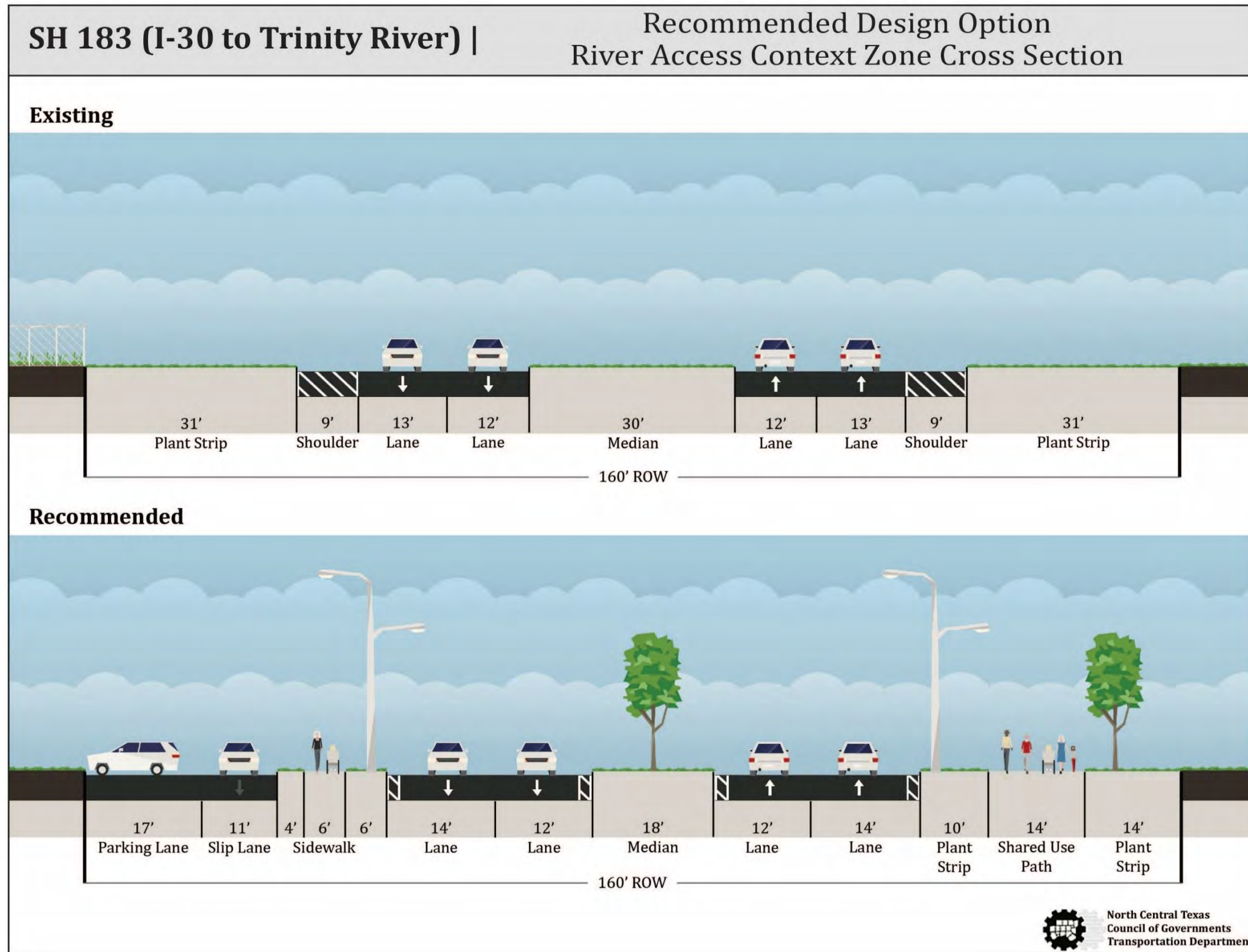
Sam Calloway Road to facilitate access to the crossing. As discussed previously, a slip lane with angled parking is recommended on the northwest side of the roadway to improve community access to the trails.

**SH 183 Just South of Bridge Over Trinity River**

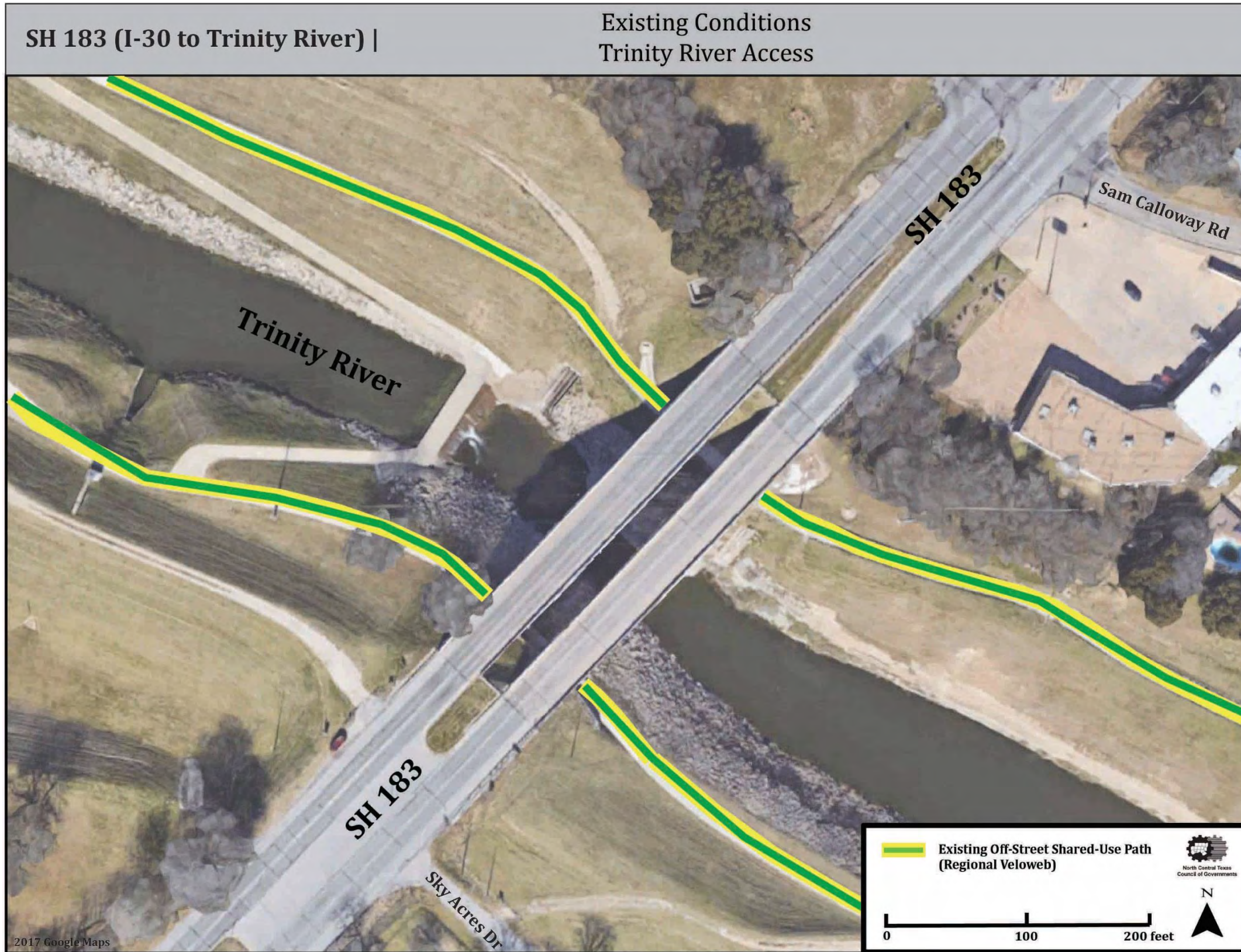




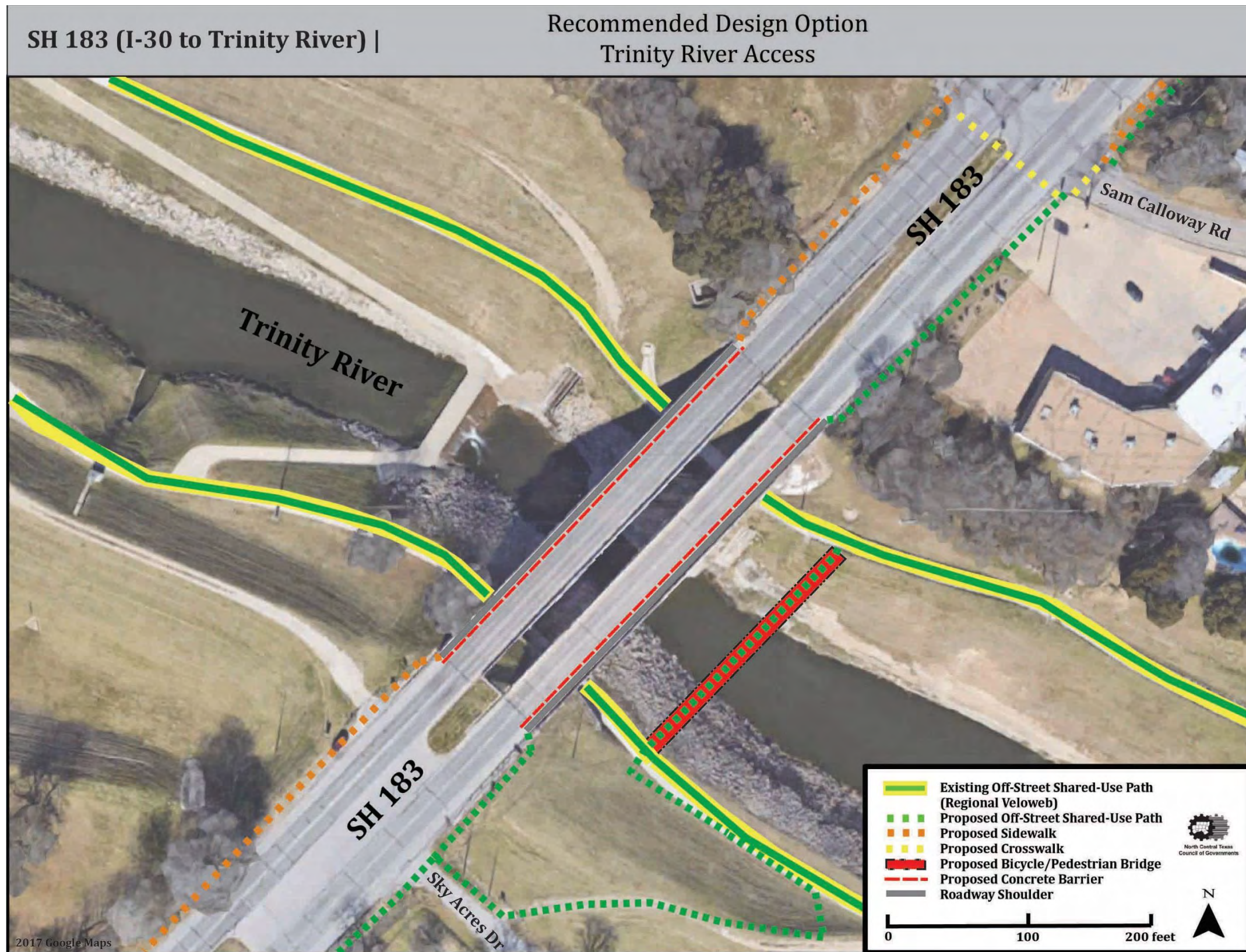
**EXHIBIT II-4: River Access Context Zone Street Cross Sections – Existing and Recommended Design Option**



**EXHIBIT II-5: River Access Context Zone – Trinity River Trail Access Existing Conditions**



**EXHIBIT II-6: River Access Context Zone – Trinity River Trail Access Recommended Design Option**



### **SH 183/White Settlement Road Intersection**

The existing and proposed street cross sections are illustrated in EXHIBIT II-7 and EXHIBIT II-8. The existing configuration of the SH 183 and White Settlement Road intersection consists of a combination of through lanes and lanes that are controlled by a traffic signal. In addition, there are lanes that merge from two to one lane as well as traffic entering the roadway from intersecting side streets. All of this contributes to multiple vehicle movements that require drivers to be very cautious to avoid crashes. From a driver's perspective, the configuration presents many safety challenges. From a pedestrian or bicyclist's perspective, there is not a safe way to cross, as there is no way to stop traffic on the through lanes. In addition, there are no sidewalks or crosswalks to direct and protect pedestrians and bicyclists.

A roundabout was initially considered at this location. However, some attendees of the first community meeting expressed concern about the concept. Instead, the recommended design option would reconfigure the intersection to a more conventional "T" signalized intersection. SH 183 would become a four-lane divided through street, while White Settlement Road would be reconfigured so that it would intersect SH 183 at a right angle. Dedicated left and right turn lanes would facilitate traffic movements. The advantages of this intersection configuration include: 1) it improves safety by providing pedestrians and bicyclists a safe way to cross at a signalized crosswalk; 2) it eliminates the merging conditions that contribute to accidents; 3) it eliminates the "short cut" from westbound White Settlement Road onto westbound SH 183; and 4) it frees up approximately 107,000 square feet of property that could be used for new development opportunities, open space, or drainage.

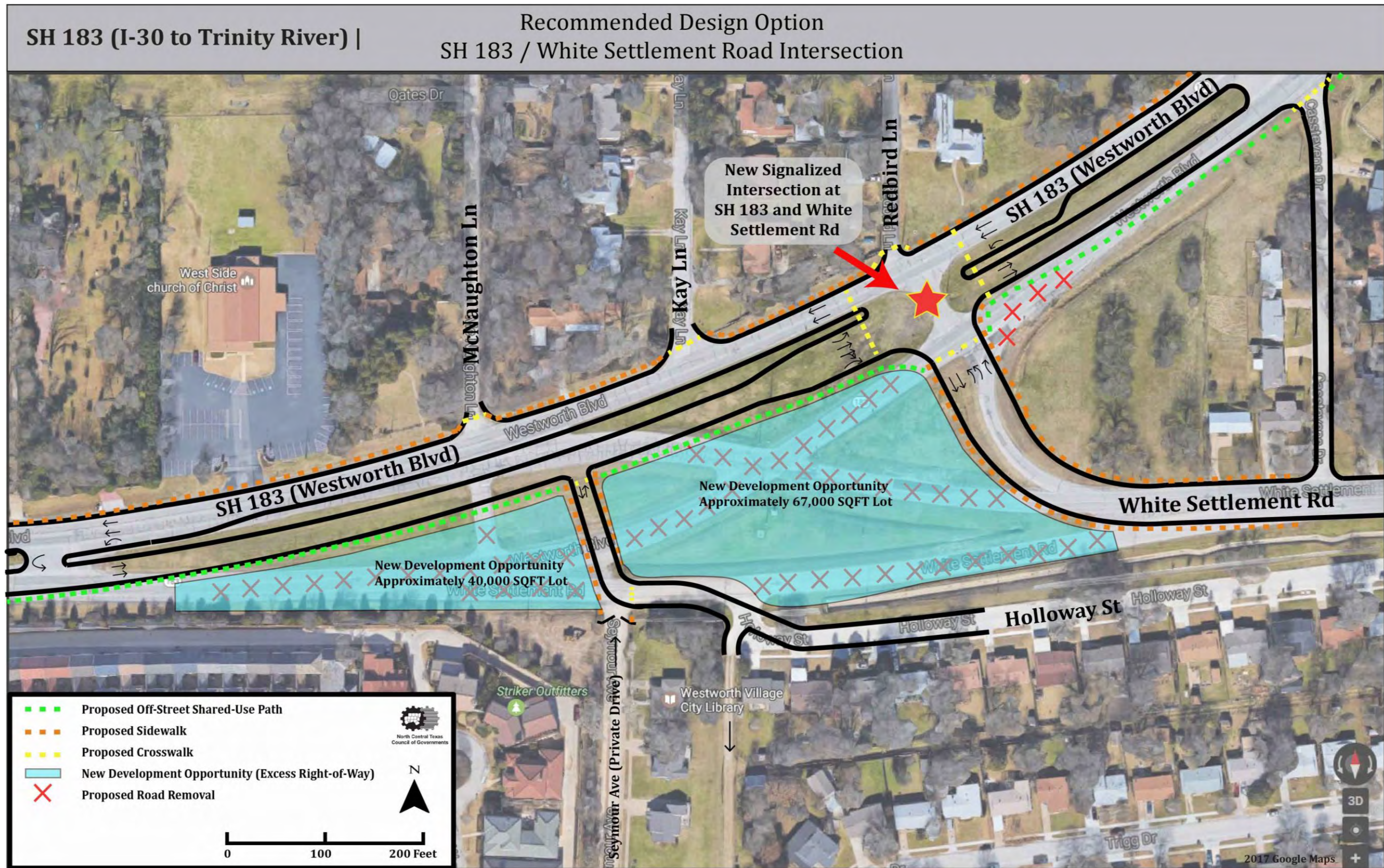
This configuration could encourage cut-through traffic on Holloway Street for drivers who wish to access White Settlement Road without waiting through the light. Holloway Street serves a residential neighborhood. It is recommended that traffic-calming measures, such as speed humps and speed reduction, be considered on Holloway Street to mitigate this issue.

This concept would need further study during the environmental and engineering stages of the corridor reconstruction to determine impacts of the reconfiguration, identify driveway locations and access for the land made available for redevelopment, and further refine the concepts.

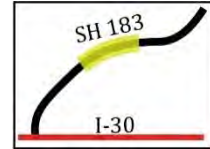
**EXHIBIT II-7: River Access Context Zone – SH 183/White Settlement Road Intersection Existing Conditions**



**EXHIBIT II-8: River Access Context Zone – SH 183/White Settlement Road Intersection Recommended Design Option**



## BASE ZONE



### Recommended Streetscape Design Option

The existing street cross section and recommended design option are illustrated in EXHIBIT II-9. The Base Context Zone generally spans the middle portion of the study corridor from Pumphrey Drive to Sherry Lane, and is characterized by access to NAS Fort Worth JRB at Pumphrey Drive, multi-family and commercial land uses, and a SH 183 right-of-way width of 160 feet. SH 183 through this zone currently has four travel lanes, and does not have any sidewalks or other pedestrian and bicycle facilities. SH 183 southwest of Pumphrey Drive has some of the highest 2040 projected traffic volumes of the study corridor. SH 183 at Roaring Springs Road also had the highest number of vehicular crashes in the study corridor, as well as a crash involving a pedestrian (see EXHIBIT I-33, page I-44).

The goals of the recommendations in the Base Context Zone are to provide adequate access to the NAS Fort Worth JRB for current and future roadway users, increase mobility options, and enhance safety. Improvements in this zone include widening SH 183 from four to six lanes as SH 183 continues southwest through Pumphrey Drive to accommodate existing and future traffic demands. Similar to the River Access Zone, a sidewalk is proposed on the northwest side and a shared-use path on the southeast side. The shared-use path would connect with the planned Bomber Spur Trail at Sherry Lane.

During stakeholder meetings, representatives of NAS Fort Worth JRB emphasized that current base residents and their families could benefit from non-motorized access to stores and services throughout the corridor. Many individuals and families living on the base do not have personal vehicles, and do not have access to food or other supplies after the base facilities close in the evening. A shared-use path along Pumphrey Drive could provide much-needed access for base residents to existing and future commercial establishments along SH 183.

Currently, design and engineering of a shared-use path that was funded through the federal Transportation Alternatives Program (TAP) is underway. The new path will start at Airfield Falls Trailhead just south of the base entrance on the east side of Pumphrey, continue south across



SH 183, and ultimately connect with SH 183 at Sherry Lane to the southwest. While the funded trail will provide a non-motorized route to the NAS Fort Worth JRB, it is more of a recreational trail which skirts the SH 183/Pumphrey Drive intersection and does not provide direct access to the SH 183 corridor. A connection to the shared-use path is recommended where the trail nears the intersection of Pumphrey Drive and SH 183, to provide more direct access from the base to the commercial establishments at the intersection, as well as to the proposed sidewalk and shared-use path network along SH 183 (see Exhibit II-11).

When completed, the shared-use path along Pumphrey will end at the Airfield Falls trailhead, just short of the entrance to NAS Fort Worth JRB. It is recommended that the NAS Fort Worth JRB and the City of Westworth Village work together to extend the path to the base entrance. This will provide a direct non-motorized transportation option from the NAS Fort Worth JRB to the rest of the SH 183 corridor.

Additional improvements to the Base Context Zone are intended to realize the community vision identified in the visual preference survey (see EXHIBIT I-34), and include landscaping in the median and along the trail, lighting to support both roadway users and sidewalk and trail users, and bus shelters for the FWTA 091 bus route stops along SH 183.

### **SH 183/Pumphrey Drive Intersection**

The existing SH 183/Pumphrey Drive intersection and recommended design option are illustrated in EXHIBIT I-9 and EXHIBIT I-10. The intersection of SH 183 and Pumphrey Drive serves as the main entrance to NAS Fort Worth JRB. A great deal of traffic moves through this intersection in the morning and evening, resulting in a substantial level of congestion. To compound the issue, Roaring Springs Road is a two-lane road that intersects with SH 183 only 800 feet to the southwest at a traffic signal. Access to Pumphrey Drive from eastbound SH 183 and westbound Roaring Springs Road requires vehicles to use a modified two-level interchange consisting of a quarter cloverleaf ramp that circles and passes below SH 183. Cloverleaf designs were standard when the interstate highway system was first built in the 1960s.

However, cloverleaf-style intersections are no longer used in modern designs due to inherent safety concerns and the large amount of land that is required for them.

Currently, Roaring Springs Road traffic that is traveling to the NAS Fort Worth JRB on Pumphrey Drive must either take a right turn onto SH 183 or take a shortcut, both of which require the driver to use the quarter cloverleaf ramp. This contributes to driver confusion and adds to the numerous lane changes and merging conditions that make the intersection unsafe. Other issues include vehicles cutting through the Quik Trip store parking lot and the numerous right turn lanes that make the overall Pumphrey Drive/Roaring Springs Road/SH 183 intersection the highest automobile crash site in the study area. From a pedestrian and bicyclist standpoint, there is no safe way to cross any of the roads as there are no sidewalks or paths, crosswalks, or pedestrian push buttons.

The proposed configuration will eliminate the signalized intersection at SH 183 and Roaring Springs Road and create an at-grade signalized intersection at Pumphrey Drive, Roaring Springs, and SH 183. A portion of the road would become a private drive serving the Quik Trip store. The portion of the road passing under SH 183 and the quarter cloverleaf would be eliminated. SH 183 and Pumphrey Drive would have double left- and right-turn lanes to facilitate traffic into and out of the base. Roaring Springs Road at SH 183 would have a single left turn lane, which would discourage traffic from using Roaring Springs Road as the primary access route to the base. SH 183 would be widened to six lanes from IH 30 to Pumphrey Drive, allowing for added capacity. Ample space for vehicles waiting at the signalized intersection would be provided by long dedicated turn lanes. Access to the Quik Trip store, the Villages at Hawks Creek apartment complex and the Hawks Creek Golf Club would be provided by left turn only turn lanes off SH 183. Access to the CubeSmart site would be provided by a proposed private drive connecting to Roaring Springs Road, and by a driveway off SH 183.

As discussed previously, sidewalks would be provided on the north side of SH 183 and a shared-use path would be provided on the south side. The signalized intersection would incorporate crosswalks to safely move pedestrians and bicyclists from one side of SH 183 to

the other. An added benefit of this configuration is that it frees up a total of 185,000 square feet of land for potential new development opportunities, open space, and/or drainage.

With this configuration, there may still be traffic issues during special events at the NAS Fort Worth JRB, which will generate more traffic than usual. One option for consideration is to include reversible lanes that could be implemented only during those events. Other temporary measures to assist with traffic flow and control could also be considered.

This concept would need further study during the environmental and engineering stages of the corridor reconstruction to determine impacts of the reconfiguration, identify driveway locations and access for the land made available for redevelopment, and further refine the concepts.

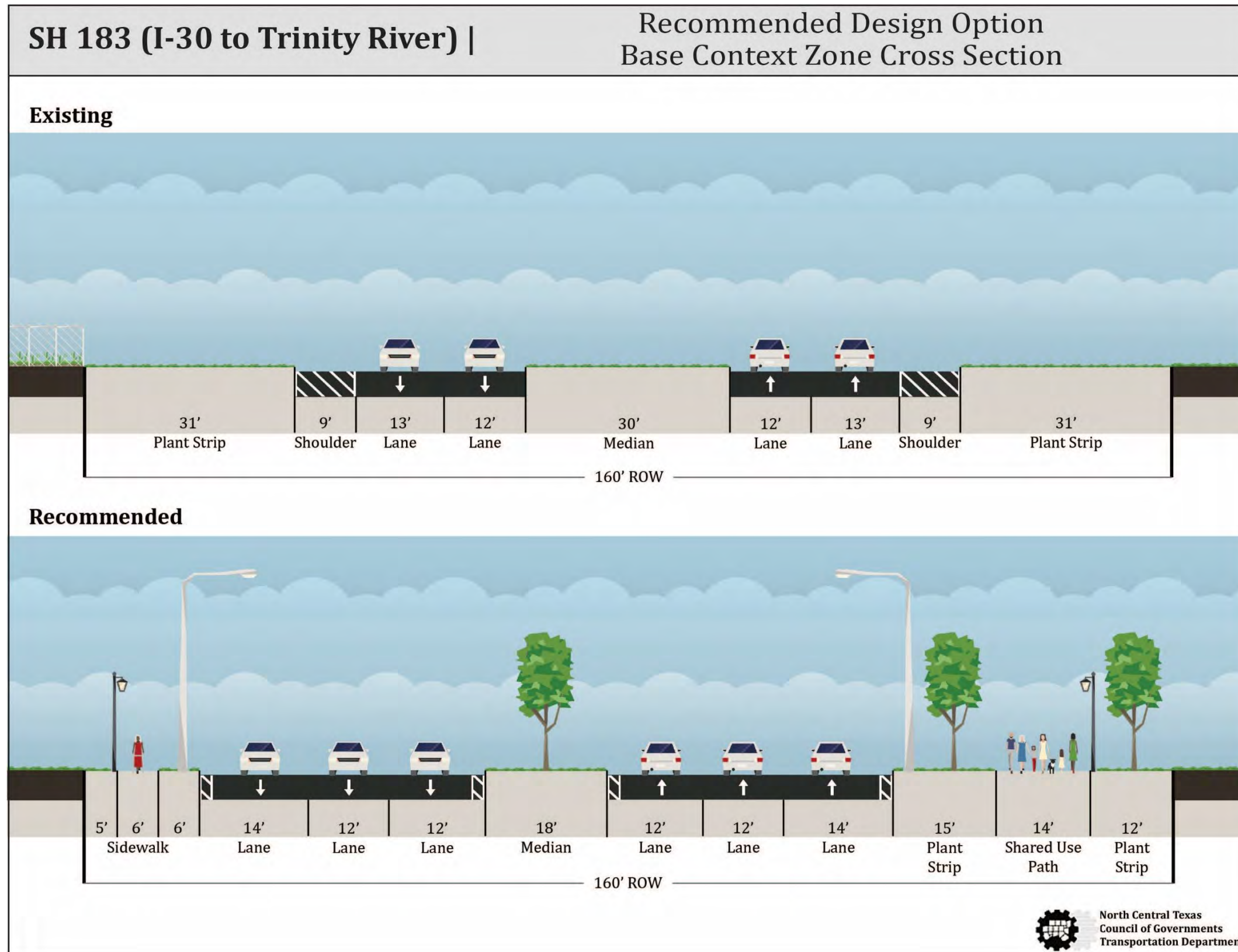
### **NAS Fort Worth JRB Base Entrance – Future Bus Stop and Turnaround**

The NAS Fort Worth JRB has indicated a need for a transit stop located near the base entrance on Pumphrey Drive to enable the troops that are housed on the base and have no vehicles or transit access to get to businesses and restaurants in the area. Currently, there is not a transit stop near the base entrance because the transit vehicles cannot turn around. The NAS Fort Worth JRB visitor's center has been considered for a bus stop; however, FWTA would require a left turn out of the visitor's center to maintain the flow of the bus route. For security reasons, that is not a viable option with the current configuration of the NAS Fort Worth JRB's entrance.

This is an area that has been identified for future study, and any final recommendations would need to be informed by a circulation study and traffic impact assessment. For discussion purposes, a preliminary bus turnaround concept was prepared that shows how a transit stop and bus turnaround could be incorporated into the area just to the west of the security entrance and the visitor's parking lot (EXHIBIT II-12). The transit vehicles would have to take a left into a new turnaround just before the security gate to get to the transit stop. They would then loop around in a clockwise direction and join traffic coming out of the base traveling south on Pumphrey Drive to SH 183. A crosswalk would connect the bus stop to the recommended shared-use path on the east side of Pumphrey Drive, and access to the base entrance. The

existing pavement would have to be replaced to accommodate the weight of the buses. This concept will continue to be revised in a collaborative fashion among the stakeholders to develop a transit option that provides base access without compromising security or operations at the NAS Fort Worth JRB.

**EXHIBIT II-9: Base Context Zone Street Cross Sections – Existing Conditions and Recommended Design Option**



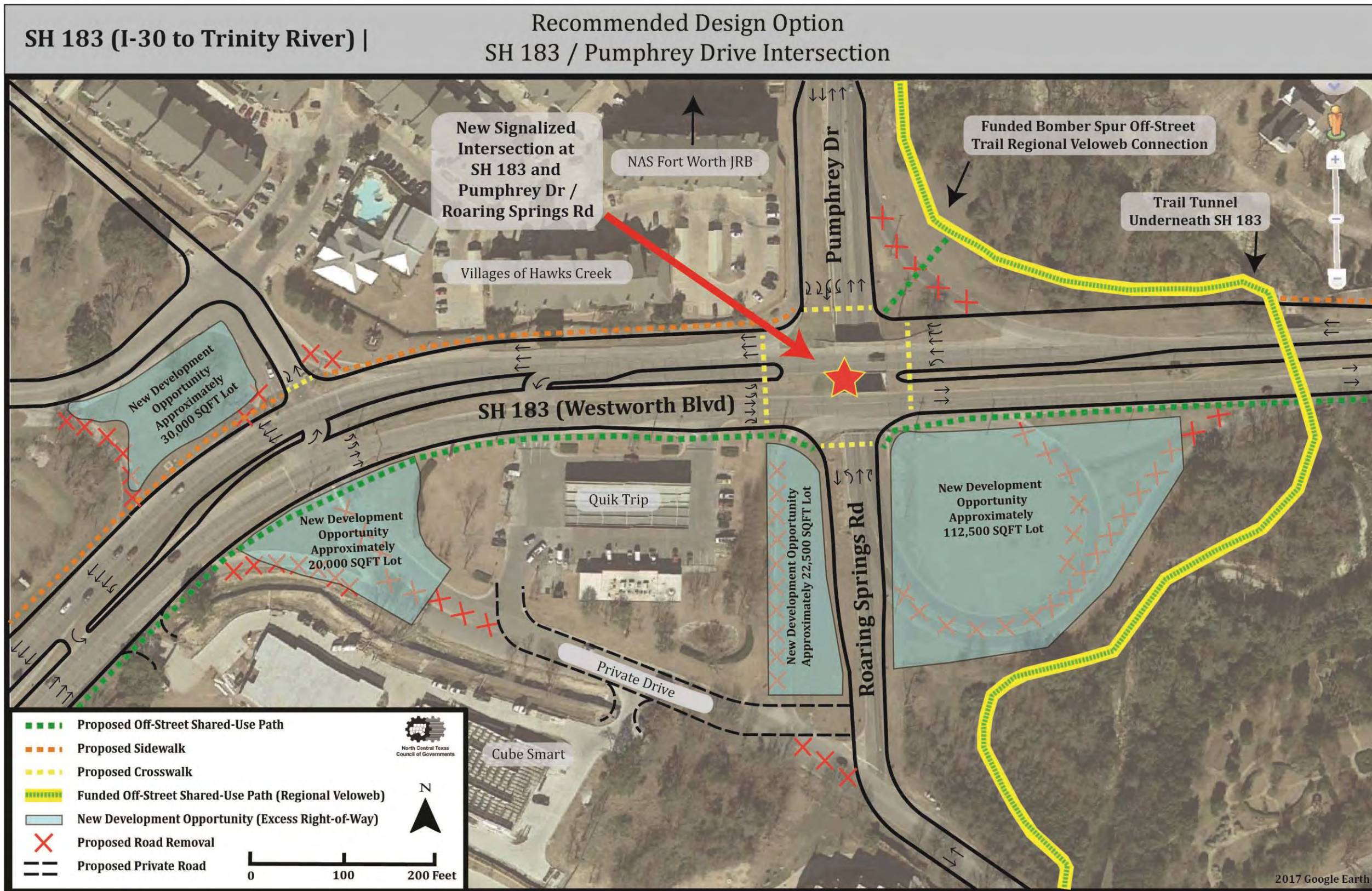
**EXHIBIT II-10: Base Context Zone – SH 183/Pumphrey Drive Intersection Existing Conditions**

SH 183 (I-30 to Trinity River) |

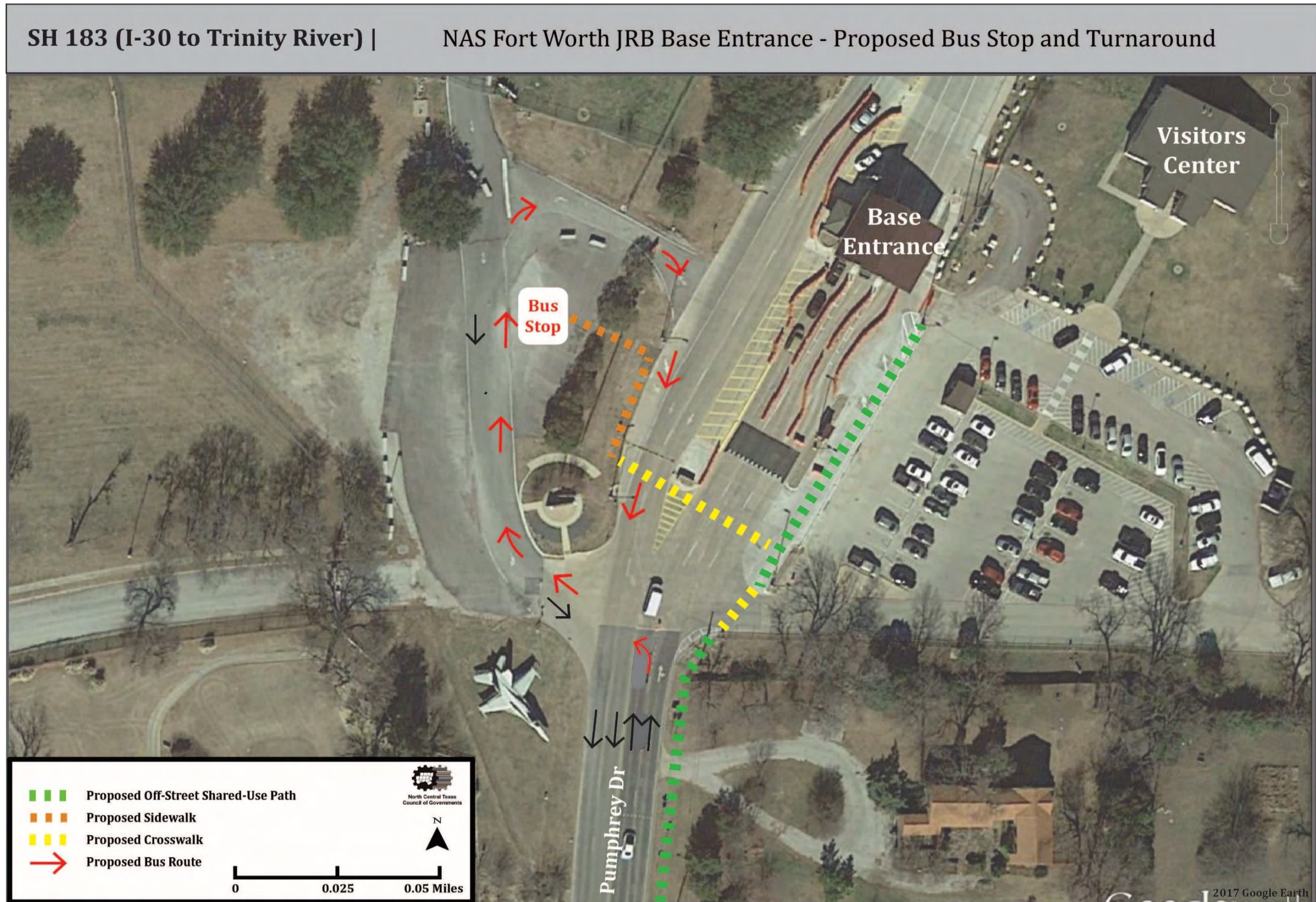
Existing Conditions  
SH 183 / Pumphrey Drive Intersection



**EXHIBIT II-11: Base Context Zone SH 183/Pumphrey Drive Intersection Recommended Design Option**



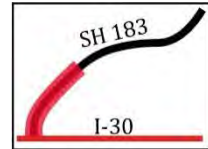
**EXHIBIT II-12: Base Context Zone NAS Fort Worth JRB Entrance Bus Stop and Turnaround Design Concept**





## COMMERCE ZONE

### Recommended Streetscape Design Option



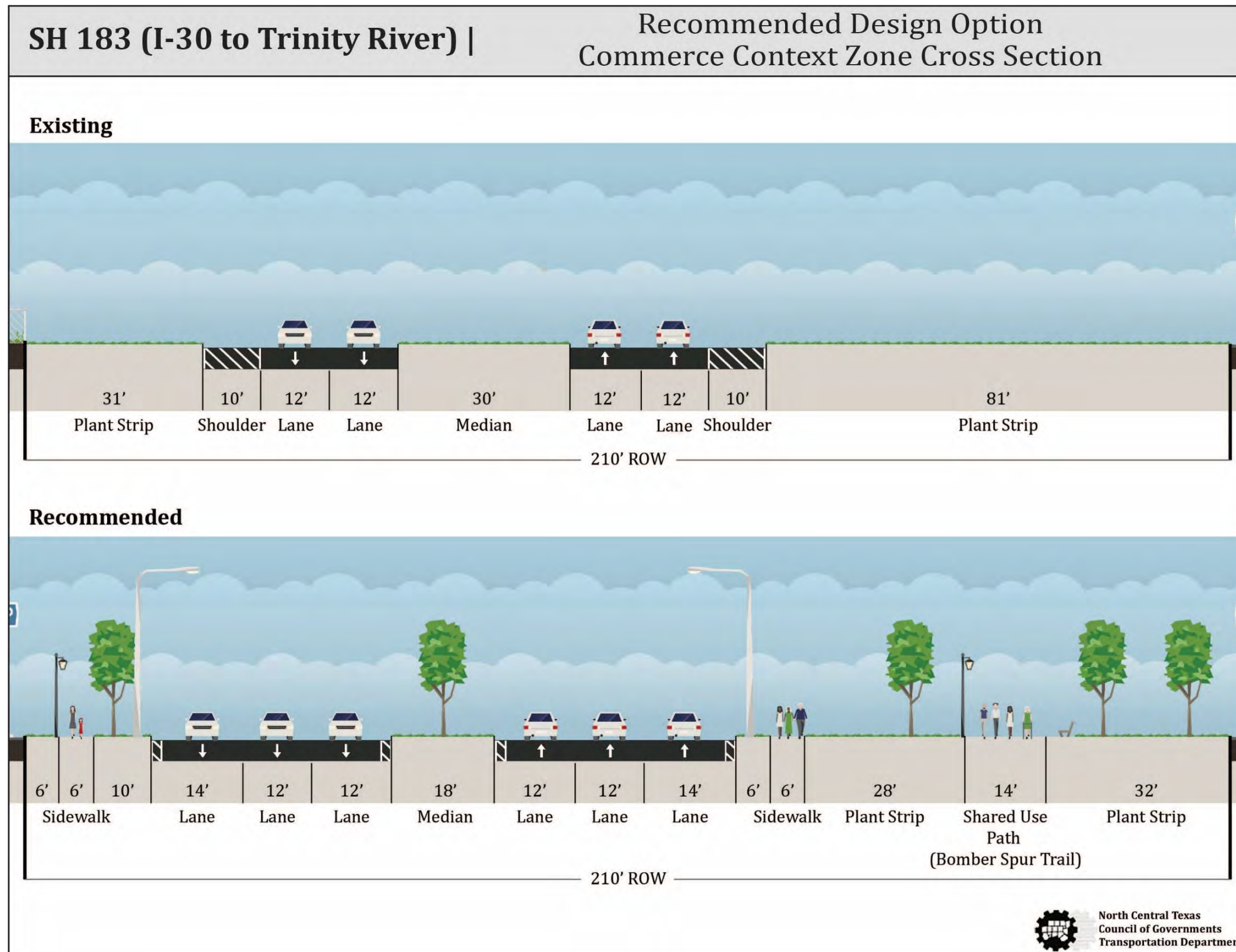
The existing street cross section and recommended design option are illustrated in EXHIBIT II-13. The Commerce Context Zone covers the southwest portion of the study corridor from Sherry Lane to the SH 183/IH 30 interchange. The Commerce Zone has the widest right-of-way in the study corridor, with an additional 50 feet of right-of-way along the southeast side of SH 183 comprised of utilities and the former Bomber Spur railroad track. The Regional Veloweb identifies a future shared-use path along the east side of SH 183, from Sherry Lane south to IH 30, also known as the Bomber Spur Trail (see EXHIBIT I-25). Similar to the River Access and Base Context Zones, SH 183 through the Commerce Zone is a four-lane roadway, and does not currently have any sidewalks or other pedestrian and bicycle facilities. There are six signalized intersections in this zone, all of which have at least one right- and one left-turn lane for both directions on SH 183; the intersection of Marquax Drive has two left turn lanes for vehicles turning north onto Marquax Drive. FWTA bus route 91 is the sole bus route active through the corridor. This route turns onto SH 183 at Green Oaks Road, and from there travels north along SH 183 through the Base and River Access Zones. Looking to the future, SH 183 from Green Oaks Road to Pumphrey Drive has the highest 2040 projected traffic volumes in the corridor.

Similar to the Base Zone, improvements to the Commerce Zone include widening SH 183 to six travel lanes to accommodate projected traffic volumes between IH 30 and NAS Fort Worth JRB. With the excess right-of-way along SH 183 through the Commerce Zone, it is recommended that SH 183 be located on the northwest side of the corridor right-of-way, and a linear park or greenway with a 14-foot-wide shared-use path (the planned Bomber Spur Trail) be created in the excess right-of-way on the southeast side. An illustration of the linear park is shown in EXHIBIT II-14. This linear park would be an opportunity to provide natural, or “green,” stormwater management, as well as greater bicycle and pedestrian connectivity to the FWTA’s Ridgmar Mall Transfer Center and Ridgmar Mall shops and restaurants when the planned

redevelopment of the site occurs. Further, the trail could act as an extension of Z Boaz Park to the south, and connect those recreational amenities to the NAS Fort Worth JRB and the Trinity River Trails, as shown in EXHIBIT II-15.

Finally, the private sector could consider opportunities to build trail connections through the redeveloped site, which could provide key walking and bicycling access to the destinations and link to the main trail system. EXHIBIT I-15 (page II-85) illustrates property ownership for the mall site and outparcels. As the corridor right-of-way narrows next to Ridgmar Mall, easements may need to be acquired so that the shared-use path may be set back farther from the roadway.

**EXHIBIT II-13: Commerce Context Zone Street Cross Sections - Existing Conditions and Recommended Design Option**



**EXHIBIT II-14: Linear Park Concept**



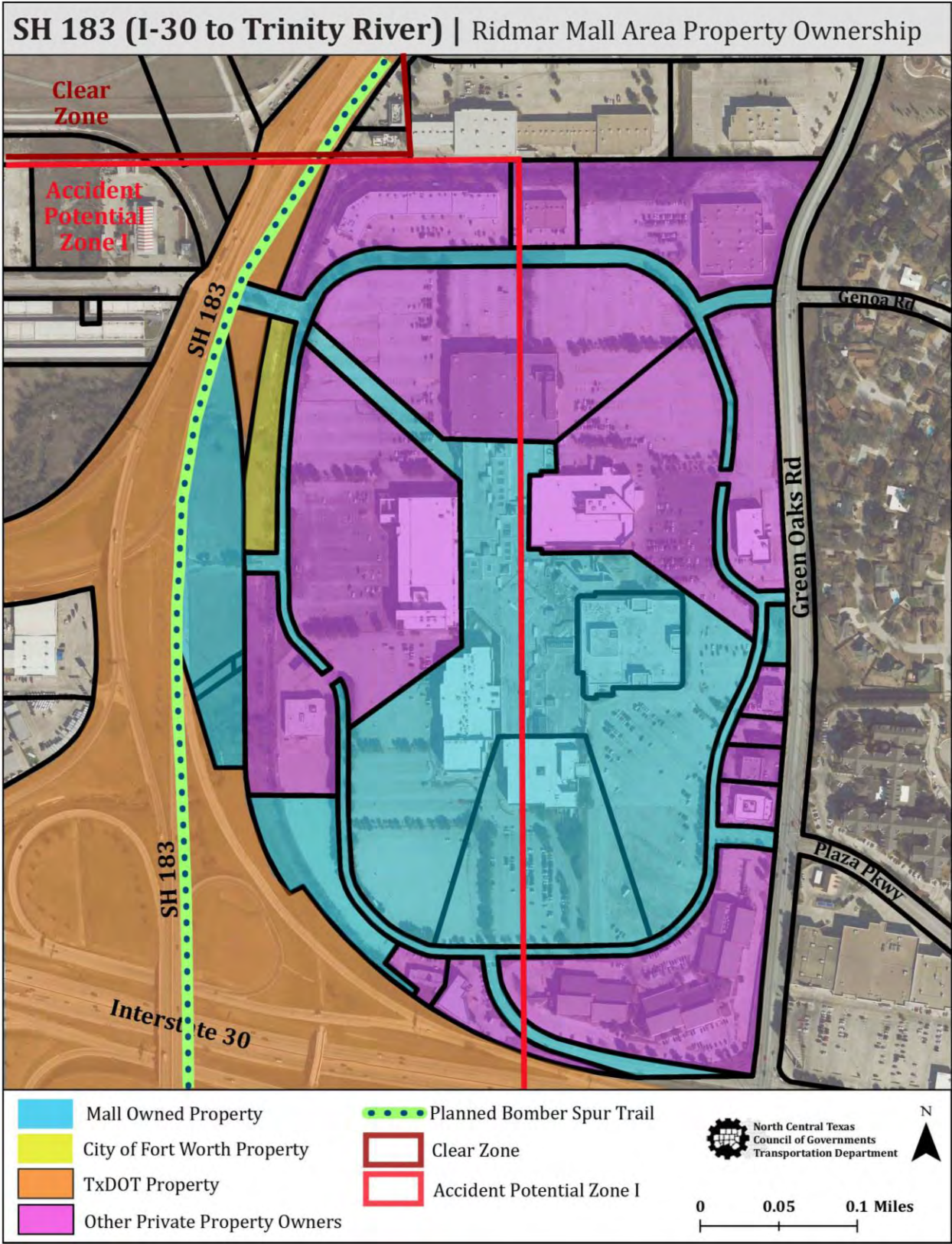
**EXHIBIT II-15: Connected Park System Concept**



The linear park combined with the mall redevelopment may also create an opportunity to develop attractive public spaces and trail-oriented development specifically serving trail users, such as Woodshed Smokehouse in Fort Worth or the developments along the Katy Trail in Dallas. Any development would need to occur outside the Clear Zone (CZ) and Accident Potential Zone (APZ) that are part of the City of Fort Worth's Airport Overlay Compatible Use Zone (AO-CUZ). The Overlay limits the type and intensity of development that can occur in the CZ and APZ, which encompasses the western half of the Ridgmar Mall site, as shown in EXHIBIT II-16. Any development to the north of the CZ and APZ will still require close coordination with NAS Fort Worth JRB and the City of Fort Worth to avoid unsafe or incompatible development in the vicinity of the base. The redevelopment of the land on the eastern side of the current mall property makes the private sector-funded tie-ins or trail spur connections to the main trail even more desirable, since redevelopment will most likely not be possible directly adjacent to the trail.

The vegetation selected for the linear park, as well as the median along SH 183, will also require close coordination with NAS Fort Worth JRB to ensure that it would not unduly attract bird and animal strike hazards (BASH). Vegetation should also be considered in coordination with the budget of the community partners that would ultimately be responsible for maintaining it. Under the TxDOT Fort Worth District Landscape and Aesthetics Master Plan (2007), if TxDOT makes formal plantings, the plant material shall be hardy varieties that can survive on minimal maintenance. Where additional formal landscaping is requested and permitted, the entity requesting the permit would be required to construct and maintain the area in accordance with TxDOT regulations as a condition of the permit. In general, plants and shrubs that are selected should be those with low maintenance requirements, but that improve the aesthetics of the roadside and along the trail, such as Indian hawthorn, crape myrtle and cedar elm trees. To the extent possible, landscaping improvements should be guided by the preferences of the community as identified in the visual preference survey (see EXHIBIT I-34).

**EXHIBIT II-16: Ridgmar Mall Area Property Ownership**



### **SH 183/IH 30 Interchange**

The current configuration of the SH 183/Lockheed Boulevard/IH 30 interchange was constructed in the 1960s and does not incorporate modern engineering design standards. The loops and ramps pose numerous safety issues to drivers trying to negotiate the complicated merging and acceleration lanes as well as the confusing routing through the interchange to get to their designation. Pedestrians and bicyclists trying to get to Ridgmar Mall or other establishments in the area must cross several lanes of traffic that do not stop. In addition, there are no north/south pedestrian or bicycle facilities across IH 30. Finally, there is no direct route for residents from White Settlement to access Ridgmar Mall without using IH 30.

TxDOT is in the early stages of planning for the reconstruction of the interchange. NCTCOG has proposed a preliminary design concept for consideration as planning and discussions for the project move forward (EXHIBIT II-17). This concept would eliminate all of the loops and ramps in favor of more traditional interstate service roads and at-grade signalized intersections at SH 183 and Lockheed Boulevard. The IH 30 corridor is currently being studied by TxDOT for upgrade; as a result, wider bridges currently on the corridor could be replaced with space for sidewalks and paths. The signalized intersections could incorporate crosswalks to protect pedestrians and bicyclists from cross traffic. The design could also connect Scott Street to SH 183, thus providing a route for White Settlement residents to access the Ridgmar Mall site without being required to use IH 30.

The traffic traveling to and from the Lockheed Martin facility would be impacted by the signalized interchanges, so provisions could be made to allow them to pass over SH 183 without stopping. Additionally, dedicated turn lanes could be provided with sufficient storage for vehicles approaching the intersection to allow for increased capacity. Signals will need to be able to accommodate the heavy traffic coming off of IH 30 during peak traffic times in the morning.

It is recommended that any turn lanes and travel lanes on the frontage road intersections be designed in a manner that safely accommodates trail users at intersection crossings. The safety of pedestrians and bicyclists at these locations should take priority over the ability of vehicles



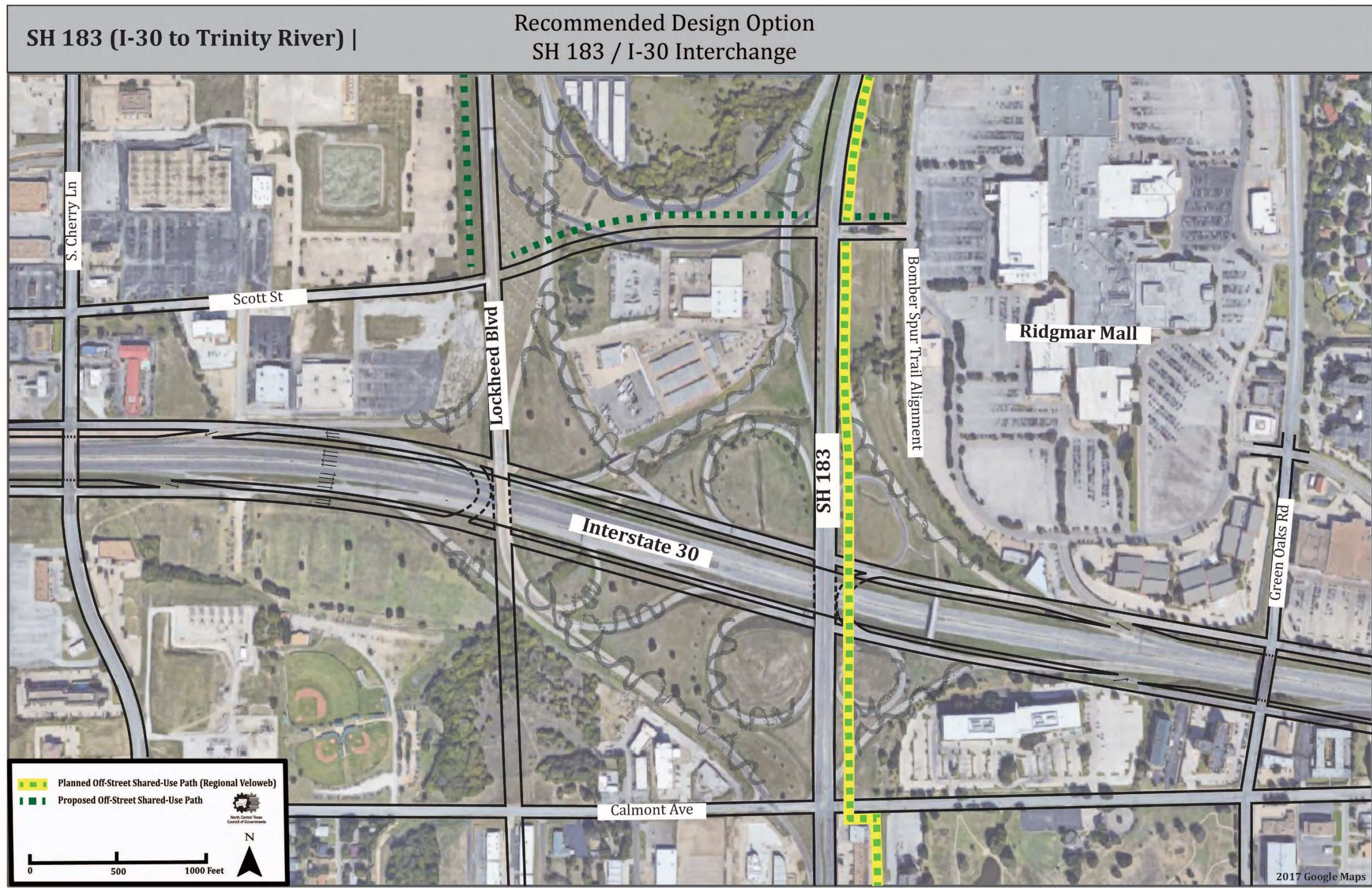
to make fast turning movements. This may require the installation of dedicated pedestrian and bicycle signal phases for the trail crossings at the intersections, paving treatments, raised crosswalks, etc. to reduce the speed of motorists and increase the visibility of non-motorized street users in the crosswalks.

Continued development of this concept will require close coordination with the stakeholders, particularly NAS Fort Worth JRB regarding transportation movements and any potential obstructions (e.g. light poles). Traffic studies and further refining of these concepts will occur during the environmental and engineering stages.

### **Bomber Spur Trail Crossing of SH 183**

Because the current interchange is in a floodplain, the IH 30 interchange may be raised as part of the reconstruction. In the event that SH 183 crosses over IH 30, TxDOT has committed to providing a bicycle and pedestrian shared-use crossing, most likely as part of the SH 183 bridge. If SH 183 passes under IH 30, then the bicycle and pedestrian shared-use path could continue along SH 183 at-grade on the east side of the roadway.

**EXHIBIT II-17: Commerce Context Zone – SH 183/IH 30 Interchange Design Concept**



## **CORRIDOR SIGNAL OPERATIONS**

One of the primary functions of the SH 183 corridor is to move traffic from NAS Fort Worth JRB and the surrounding communities in the area to and from IH 30. To traverse this corridor, vehicles must travel through eight signalized intersections between NAS Fort Worth JRB and IH 30. At some points along the route, through traffic is stopped unnecessarily in favor of cross traffic. This causes congestion and frustration, and sometimes results in drivers resorting to searching for alternate routes such as the two-lane Roaring Springs Road.

Future upgrades to the traffic signals along the corridor could include advanced systems that provide for coordinated signal timing. Traffic signals could be redesigned and replaced to incorporate modern pedestrian safety features. The normal function of traffic lights requires more than slight control and coordination to ensure that traffic moves as smoothly and safely as possible and that pedestrians are protected when they cross the roads. A variety of different control systems are used to accomplish this, ranging from simple clockwork mechanisms to sophisticated computerized control and coordination systems that self-adjust to minimize delays. Coordinated signal timing synchronizes traffic movements and manages the progression speed of specific modes where uninterrupted flow is desired along a corridor. While traditionally applied to increase vehicular traffic flow and to reduce peak-hour delay, coordination of traffic signals can reduce the number of stops along a corridor and provide for a continuous flow of traffic at the target speed.

Traffic signals on a coordinated system provide drivers with a green wave, or a long string of green lights. The distinction between coordinated signals and synchronized signals is very important. Synchronized signals all change at the same time and are only used in special instances or in older systems. Coordinated (progressed) systems are controlled from a master controller and are set up so lights "cascade" (progress) in sequence so groups of vehicles can proceed through a continuous series of green lights.

## **IMPLEMENTATION STEPS AND STRATEGIES**

### **Near-Term Implementation and Cost**

Because SH 183 is on the State highway system, the Cities of Westworth Village, White Settlement, and Fort Worth would develop a strategy with TxDOT and assess partnership opportunities for a phased approach for improvements. The following sections provide details on the proposed near-term and long-term improvements for each context zone described previously. The context zones could potentially serve as geographic delineations for phases as funding becomes available. The SH 183 (Trinity River to IH 30) Corridor Master Plan is intended to provide the Cities of Westworth Village, White Settlement, and Fort Worth with strategies to enhance and encourage development, mobility, and aesthetics in the corridor. The following are near-term steps that project stakeholders can undertake to enhance the corridor within five years.

1. It is recommended that the cities, Tarrant County and TxDOT continue to champion the need for long-term infrastructure improvements along the corridor to improve economic development and both motorized and non-motorized mobility. With a TxDOT on-system facility such as this one, the next step is to produce a schematic-level engineering design (30 percent design), including a hydraulics and hydrology study, and environmental document.
2. Additionally, it is recommended that a SH 183 Corridor Coalition be formed to bring together the necessary parties and resources to continue to encourage implementation of the plan and to identify funding and other resources.
3. Pedestrian mobility can immediately be improved along the corridor through the striping of crosswalks at major signalized intersections. Painting is a near-term solution that can be achieved at a low cost, but could affect circulation and mobility throughout the corridor. It is also recommended that the cities coordinate with TxDOT and NCTCOG to investigate retiming the signals along the corridor to improve traffic flow.

4. To traverse this corridor, vehicles must travel through eight signalized intersections between the NAS Fort Worth JRB and IH 30. At some points along the route, through traffic is stopped unnecessarily in favor of cross traffic. Coordination of traffic signals can reduce the number of stops along a corridor and provide for a continuous flow of traffic at the target speed.
5. Agencies work to develop a phasing plan for SH 183 from IH 30 to SH 199 with segments to submit for federal, state, and regional funds as opportunities become available.

### **Long-Term Implementation and Cost**

A phased implementation plan in which each zone would be constructed incrementally over five to 10 years or as funding becomes available is recommended. The Cities of Westworth Village, White Settlement, and Fort Worth, in conjunction with TxDOT, can decide the order of the Context Zones to be implemented based on available funding and developer interest. One zone may be more financially feasible than others depending on the will of developers and potential financing strategies that the cities may employ to assist in offsetting the cost of the capital improvements. EXHIBIT II-18 shows preliminary estimates of probable cost for implementing the corridor plan per Context Zone.

**EXHIBIT II-18: Preliminary Estimates of Probable Cost**

	<b>River Access Zone</b>	<b>Base Zone</b>	<b>Commerce Zone</b>	<b>Total</b>
General	\$1,078,681	\$1,270,505	\$1,314,429	\$3,663,615
Roadway	\$5,029,955	\$2,657,446	\$5,979,469	\$13,666,870
Drainage	\$1,368,900	\$753,570	\$2,173,640	\$4,296,110
Bridge	\$518,000	\$0	\$0	\$518,000
Signals	\$250,000	\$70,000	\$250,000	\$570,000
Illumination	\$1,404,864	\$570,180	\$1,404,864	\$3,379,908
Signing	\$50,700	\$27,910	\$80,000	\$158,610
Pavement Markings	\$40,560	\$22,328	\$65,000	\$127,888
Landscape	\$380,250	\$209,325	\$600,000	\$1,189,575
<b>Subtotal Construction</b>	<b>\$10,121,910</b>	<b>\$5,581,264</b>	<b>\$11,867,402</b>	<b>\$27,570,576</b>
Mobilization	\$574,540	\$316,742	\$702,052	\$1,593,334
Utilities	\$1,149,081	\$633,483	\$1,404,104	\$3,186,669
Miscellaneous	\$804,357	\$443,438	\$982,873	\$2,230,668
Contingencies	\$2,872,702	\$1,583,709	\$3,510,261	\$7,966,671
Engineering	\$810,102	\$446,606	\$989,893	\$2,246,601
Inflation	\$216,027	\$119,095	\$263,972	\$599,094
<b>Subtotal Other Items</b>	<b>\$6,426,810</b>	<b>\$3,543,073</b>	<b>\$7,853,155</b>	<b>\$17,823,037</b>
<b>Project Total</b>	<b>\$16,548,720</b>	<b>\$9,124,337</b>	<b>\$19,720,557</b>	<b>\$45,393,613</b>

**Funding Strategies**

A combination of funding sources is necessary for the reinvention of the SH 183 corridor. As is typical in any infrastructure improvement project, a myriad of options are available, including both public and public/private partnership sources. There are also many funding sources available that help develop funding strategies for the present and the near future.

The following discussion addresses a series of approaches that can serve as catalysts to secure the necessary funding for corridor improvements.

## **Bonds**

Municipal bonds are issued by municipalities to raise funds necessary to pay for desired infrastructure and other capital improvements. Bonds are attractive to investors because they offer tax free interest and are guaranteed investments. A bond could be a creative solution to fund the cost of infrastructure improvements along the SH 183 corridor.

## **Public Improvement District**

A Public Improvement District (PID) is a special assessment area created so that property owners finance specific types of maintenance or improvements. A PID can fund supplemental improvements (including infrastructure, landscaping, and design elements) that would not otherwise be constructed. In general, a PID should serve a very specific purpose, and needs to be self-sufficient so it does not impact the standard services that are provided by the City. PIDs should only be implemented in targeted areas of a community.

The creation of a PID around the SH 183 corridor would help fund the infrastructure improvements and help the area achieve unique aesthetic, design, and character-making goals.

A PID would be most likely to succeed if the business owners, landowners, and other stakeholders agreed that its creation would spur positive change along the corridor and to their properties.

## **Transportation Alternatives Set-Aside Program**

The Federal Highway Administration funds the Transportation Alternatives Set-Aside (TA Set-Aside) Program, a set-aside of the Surface Transportation Block Grant Program. According to FHWA, the TA Set-Aside Program funds “a variety of smaller-scale transportation projects such as pedestrian and bicycle facilities, recreational trails, safe routes to school projects, community improvements such as historic preservation and vegetation management, and environmental mitigation related to stormwater and habitat connectivity.”

The addition of shared-use bicycle paths, additional pedestrian amenities, and the general details of the SH 183 corridor proposed improvements make the project a prime candidate for

submission for a TA Set-Aside grant because of the transportation alternatives that would be created within the existing right-of-way.

### **Tax Increment Financing District**

A Tax Increment Financing (TIF) District is a special area where the increment in tax revenue is used within the district for capital improvement projects. The goal of a TIF is to stimulate new private investment while simultaneously increasing property taxes. Any increase in the tax revenues is paid into the TIF fund that is used to finance improvements such as landscaping, lighting, renovations, demolitions, etc. TIFs are creative ways for a community to invigorate a specific area without drawing funds from other municipality coffers.

### **Transportation Investment Generating Economic Recovery Discretionary Grant**

The Transportation Investment Generating Economic Recovery (TIGER) Discretionary Grant program is a grant program managed by the U.S. Department of Transportation to build and repair freight and passenger networks. The SH 183 (Trinity River to IH 30) Corridor Master Plan project may qualify for TIGER funding since it meets the program goals in that it is intended to generate economic development and improve access to safe transportation facilities for the communities it serves. The 2017 grant applications were due in October 2017, so it is recommended that the cities register with Grants.gov and begin preparations to apply for a grant in 2018.



### **III. APPENDIX**

#### **A. COMMUNITY MEETING SUMMARIES**

## **SH 183 (Trinity River to I-30) Community Meeting 1 Comments**

### **Comment Forms**

1. Look at ways to provide access to go in and out of the base entrance for a bus turnaround, like a bus lane
2. Consider an east-west transit route on White Settlement Rd getting residents to the Stockyards/West 7<sup>th</sup>
3. Access to the river is needed (parking, pathways). I live 2 blocks from the river and cannot safely access
4. It would be good to have a continuous path along SH 183 to walk safely to the park and the trails

### **Commerce Zone Boards**

- 1. General**
  - a. Who maintains the road?
  - b. Sidewalks may not be used in the entire corridor
- 2. Streetscape Concept 1**
  - a. I love using the old Bomber Spur as a trail
- 3. Streetscape Concept 2**
  - b. Widen to six lanes to anticipate new traffic

### **Base Zone Boards**

- 1. General**
  - a. Westworth Trail (bomber spur trail) may eliminate the need for a shared use path through the base zone that is parallel to SH 183 on the south side.
  - b. The QuikTrip cut through traffic is a huge issue currently.
  - c. How do the intersection concepts affect Fairway Drive?
  - d. I support the cleaning up of confusing streets in this area
  - e. A stoplight at Roaring Springs Road and Carb/Tracyne Drive is needed so we won't have cars speeding
  - f. Mornings are bad for traffic on Roaring Springs Road
  - g. Concerns about traffic and crashes on Roaring Springs Road
  - h. We need to think about bus destinations in this area: Quik Trip, storage facility, vacant commercial property
- 2. Streetscape Concept 1**
- 3. Streetscape Concept 2**
- 4. Streetscape Concept 3**
  - a. Widen to six lanes
- 5. Pumphrey Concept 1**
  - a. This concept is the only acceptable concept
  - b. Concept 1 is preferable
  - c. Divert traffic off of Roaring Springs and onto SH 183 from I-30
  - d. No commercial traffic on Roaring Springs

## **6. Pumphrey Concept 2**

- e. Do not like this concept – it does not keep traffic off Roaring Springs
- f. How is this concept making traffic faster than concept 1?
- g. Busy weekend would make this area a traffic concern
- h. How do you access the QuikTrip from Roaring Springs Road in this concept?
- i. Do not bring more cars to Roaring Springs Road
- j. Weekend traffic into the base backs up onto Roaring Springs, and would continue to do so in this concept
- k. I probably favor this option, but we do need to minimize traffic on Roaring Springs Rd
- l. I like that it reduces weaving, adds extra turn lanes, and allows for pedestrians
- m. Brilliant flat intersection design. It would solve the idea of a trail tunnel which is too expensive and will inhibit future expansion needs of SH 183 and potential storm water collection issues. It opens up usable land for new development, parks, or stormwater detention ponds.

## **River Access Zone Boards**

### **1. General**

- a. Keep the street safe
- b. Anticipate growth and motor vehicle speed
- c. Please no commercial property in this area
- d. Open the commercial gate on reserve weekends which takes traffic off Roaring Springs and stops backups on SH 183 east

### **2. Streetscape Concept 1**

- a. I like the on-street parking for trial access

### **3. Streetscape Concept 2**

- a. For the future, make the corridor six lanes

### **4. White Settlement Concept 1**

- a. This is in the Westworth Village original master plan
- b. Would people actually use the sidewalks in this area?
- c. I like concept 1 because it is similar to existing

### **5. White Settlement Concept 2**

- a. Absolutely not, do not like this concept
- b. I like roundabouts
- c. I like it slows down traffic which prevents high-speed accidents
- d. Does this cover traffic in the future?
- e. Do not like potential safety hazards
- f. I like that it provides continuous flow and slows down the flow
- g. Some people do like the roundabout intersection design (safe and speedy access and exit to the base)

### **6. Trail Access Concept 1**

- a. Concept 1 is acceptable, 2 is not
- b. I like that it keeps people off of the low water crossing
- c. This concept will work and we definitely need the ability to park on the side of the road

**7. Trail Access Concept 2**

- a. I like that it keeps people off the low water crossing
- b. We are in favor of a trail bridge, much faster and less interruption of traffic.

**Comments Received Via Email**

*Received 4/26/17*

**White Settlement Concept 1**

Like the roundabout

**Pumphrey Concept 2**

Like this concept – provide safe/speedy access/exist to base, opens land for new development, parks, stormwater detention. Could use a portion of the existing Pumphrey road tunnel under 183 for the trail tunnel?

**Trail Access Concept 2**

More in favor of this concept; this approach used in other parts of the country.

## **SH 183 (Trinity River to I-30) Community Meetings 2 & 3 Comments**

### **Questions/Comments during Q&A**

#### **Cross Sections / Linear Park**

1. The shared-use path through the proposed linear park—do not have curves in the path for no reason (have curves just to have curves), unless they are curving around some sort of natural or man-made feature. Many sharp curves can make it more difficult for cyclists to navigate; gradual curves are better. Landscape design will suggest that long smooth curves are more attractive, especially when they are skirting natural barriers such as outcroppings and creeks.
2. Some of us want to or have to ride long recumbent bicycles. Trail design should consider bikes up to 9.5 ' long that do not turn easily and that are difficult in blind corners. Especially for handicapped riders that are more likely to be on a recumbent.
3. Who would maintain the proposed greenery along the corridor?

#### **Trinity River Access**

1. Ramps from the river bottom to the tops of the levees need to be considered. They are steep uphill climbs and you often intersect the oncoming traffic on the trail. For example, the connection behind Westworth Village City Hall. Ramp is right to left as you face the river, which means you connect into the oncoming traffic on the right hand side of the trail as they go left to right. Some sort of landing space would be helpful.

#### **Pumphrey Drive Intersection**

1. A turnaround before the Base entrance would be helpful for people who don't know where they're going.
2. Have you talked to the property owner of the future development to the east of CubeSmart, which is to be private office space?
3. There is an old White Settlement cemetery on the east side of SH 183 just to the south of Roaring Springs (existing). Does the proposed redesign of the Pumphrey/Roaring Springs intersection get rid of access to the cemetery? This would be a concern for White Settlement residents that visit the cemetery.

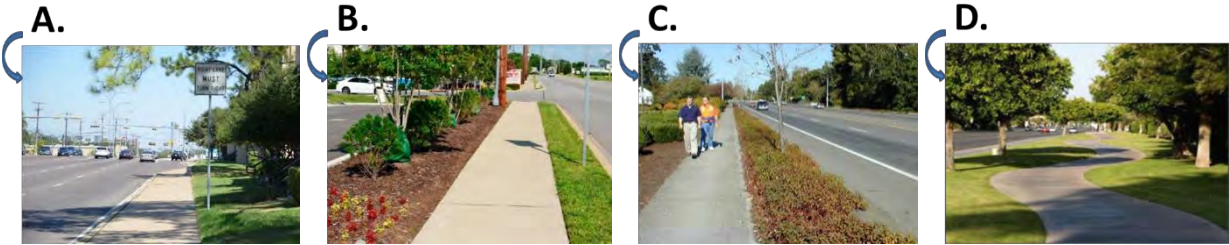
#### **IH 30 Interchange**

1. [Under the proposed IH 30 reconfiguration,] once vehicles traveling south on Lockheed Blvd. get to Calmont Ave., then what?
2. Some people from White Settlement currently walk through the fields to get over to Ridgmar Mall. Improved connectivity between White Settlement and the mall would be a good thing.
3. There used to be a street (Scott Street?) that connected through to SH 183 before the base extended the runway.
4. A lot of people that leave Lockheed Martin want to get to SH 183 to go south—more than are going to IH 30 to go back east. A lot of people live in Benbrook, Granbury (along the route to US 377). So how can they get over to SH 183 to go south without sitting through all of the proposed traffic lights? What about keeping that existing access road that cuts diagonally between Lockheed and SH 183, south of IH 30?

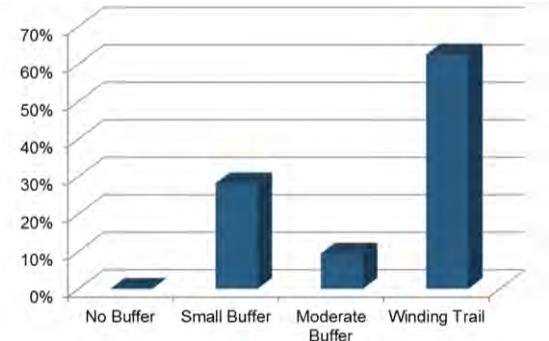
**B. VISUAL PREFERENCE SURVEY (FULL) RESULTS AND CHARTS**

The following instructions were given to participants prior to beginning the Visual Preference Survey: select only one answer choice per slide—your preferred option.

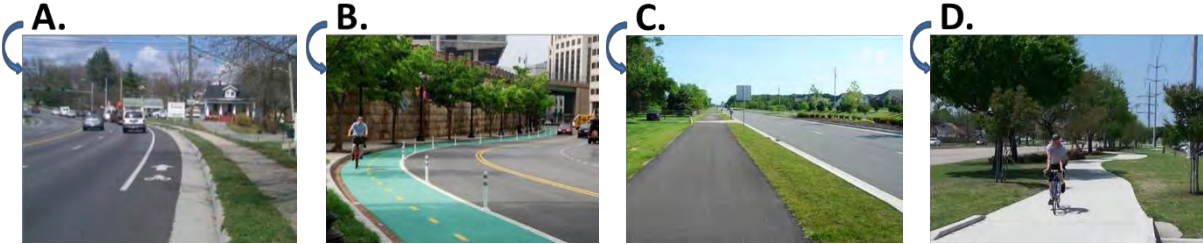
**1. Sidewalk Buffers**



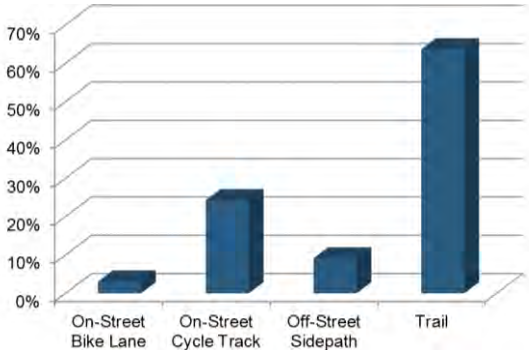
Responses		
	Percent	Count
No Buffer	0.00%	0
Small Buffer	28.13%	9
Moderate Buffer	9.38%	3
Winding Trail	62.50%	20
<b>Totals</b>	<b>100%</b>	<b>32</b>



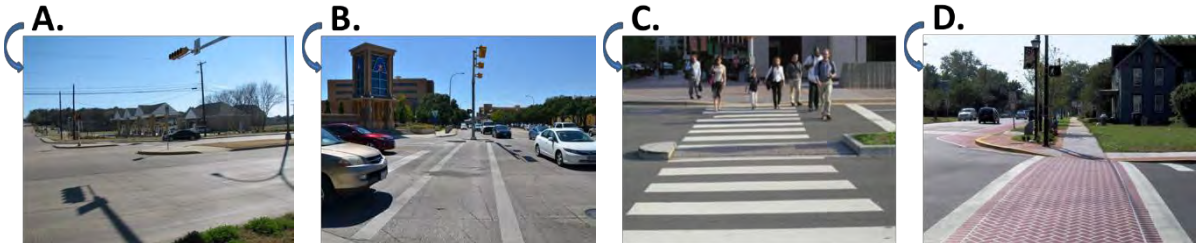
**2. Bicycle Facilities**



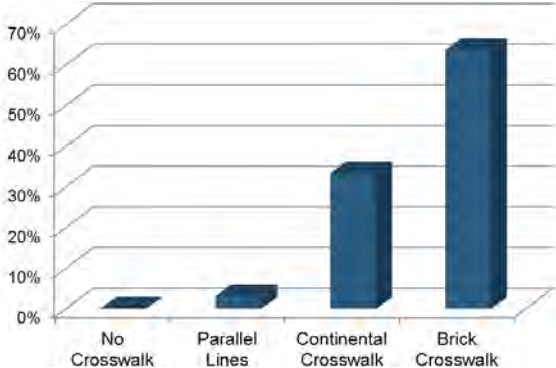
Responses		
	Percent	Count
On-Street Bike Lane	3.03%	1
On-Street Cycle Track	24.24%	8
Off-Street Sidepath	9.09%	3
Trail	63.64%	21
<b>Totals</b>	<b>100%</b>	<b>33</b>



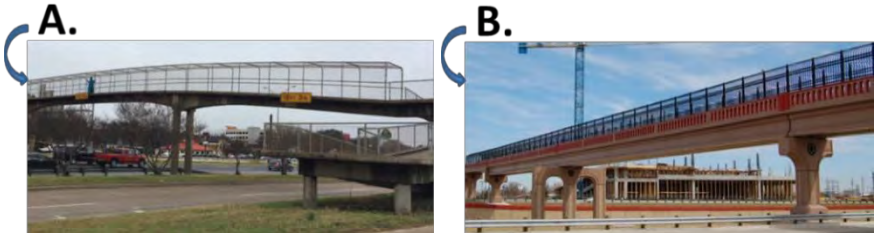
**3. Pedestrian Crossings**



Responses		
	Percent	Count
No Crosswalk	0.00%	0
Parallel Lines	3.03%	1
Continental Crosswalk	33.33%	11
Brick Crosswalk	63.64%	21
<b>Totals</b>	<b>100%</b>	<b>33</b>

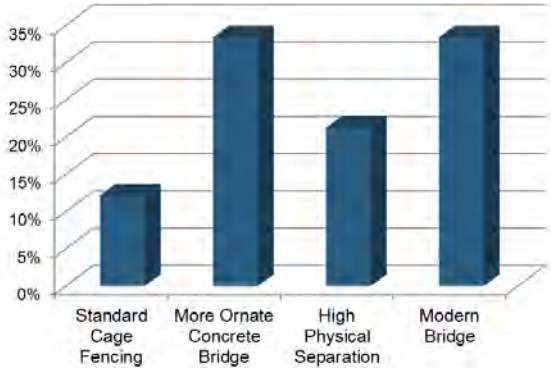


**4. Bicycle/Pedestrian Bridge over Freeway**





Responses		
	Percent	Count
Standard Cage Fencing	12.12%	4
More Ornate Concrete Bridge	33.33%	11
High Physical Separation	21.21%	7
Modern Bridge	33.33%	11
<b>Totals</b>	<b>100%</b>	<b>33</b>

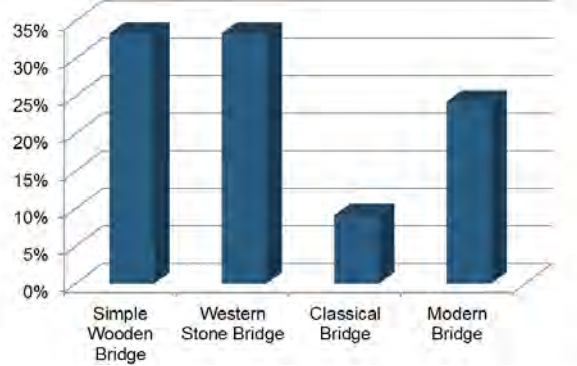


**5. Bicycle/Pedestrian Bridge Over River or Small Road**





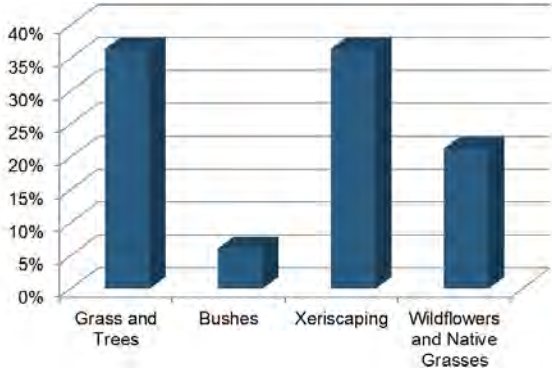
	Responses	
	Percent	Count
Simple Wooden Bridge	33.33%	11
Western Stone Bridge	33.33%	11
Classical Bridge	9.09%	3
Modern Bridge	24.24%	8
<b>Totals</b>	<b>100%</b>	<b>33</b>



**6. Landscaping Along the Road**



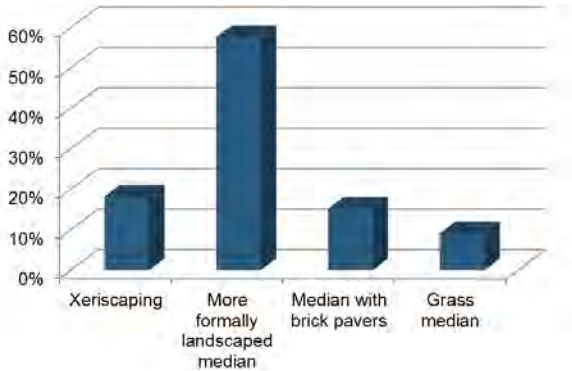
	Responses	
	Percent	Count
Grass and Trees	36.36%	12
Bushes	6.06%	2
Xeriscaping	36.36%	12
Wildflowers and Native Grasses	21.21%	7
<b>Totals</b>	<b>100%</b>	<b>33</b>



**7. Median Landscaping**



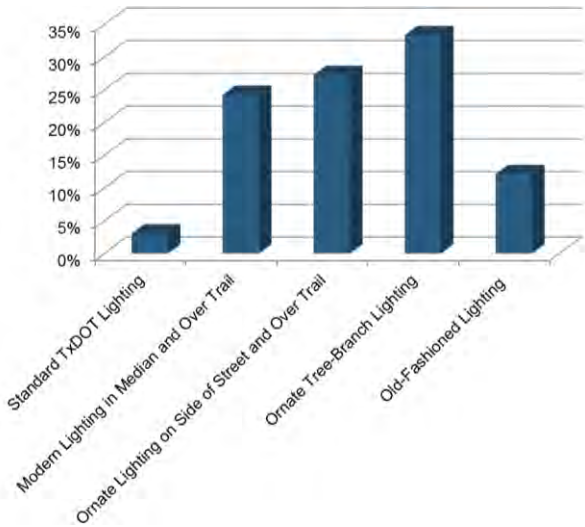
	Responses	
	Percent	Count
Xeriscaping	18.18%	6
More formally landscaped median	57.58%	19
Median with brick pavers	15.15%	5
Grass median	9.09%	3
<b>Totals</b>	<b>100%</b>	<b>33</b>



8. Lighting



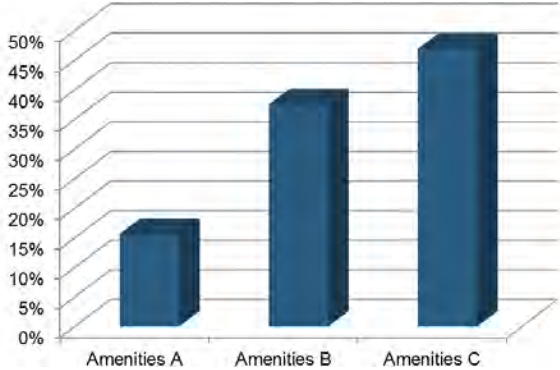
	Responses	
	Percent	Count
Standard TxDOT Lighting	3.03%	1
Modern Lighting in Median and Over Trail	24.24%	8
Ornate Lighting on Side of Street and Over Trail	27.27%	9
Ornate Tree-Branch Lighting	33.33%	11
Old-Fashioned Lighting	12.12%	4
<b>Totals</b>	<b>100%</b>	<b>33</b>



**9. Pedestrian Amenities**



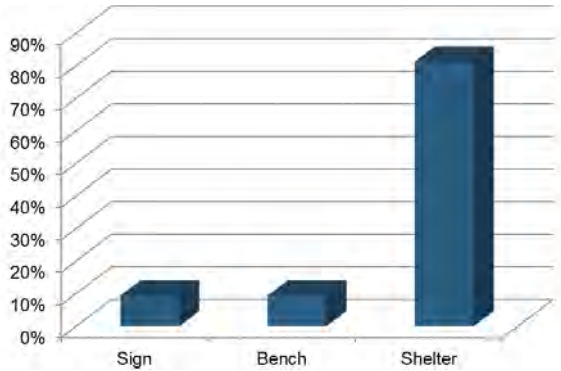
	Responses	
	Percent	Count
Amenities A	15.63%	5
Amenities B	37.50%	12
Amenities C	46.88%	15
<b>Totals</b>	<b>100%</b>	<b>32</b>



**10. Bus Stop Design**



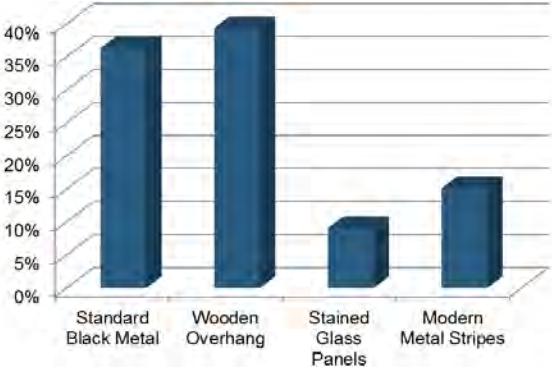
	Responses	
	Percent	Count
Sign	9.38%	3
Bench	9.38%	3
Shelter	81.25%	26
<b>Totals</b>	<b>100%</b>	<b>32</b>



**11. Bus Shelter Design**



	Responses	
	Percent	Count
Standard Black Metal	36.36%	12
Wooden Overhang	39.39%	13
Stained Glass Panels	9.09%	3
Modern Metal Stripes	15.15%	5
<b>Totals</b>	<b>100%</b>	<b>33</b>



## C. DESIGN GUIDELINES

The following design guidelines were used throughout the development of the recommended design options and are provided here as a reference for future refinement of the corridor designs.

### **Texas Department of Transportation – Roadway Design Manual**

The Texas Department of Transportation’s *Roadway Design Manual* was developed by TxDOT to provide guidance on the design of highways, from freeways to two-lane roads. SH 183 is a TxDOT facility; therefore, the *Roadway Design Manual* was the first point of reference for the proposed corridor design, particularly the design of traffic management and lane widths. The following are some of the relevant design guidance:

- Lane Width: 11 or 12 feet for urban arterials, 10 to 12 feet for urban local streets
- Median Width: For low-speed urban arterial streets, 16 foot width is necessary to accommodate left-turning traffic. Where the need for dual left turns are anticipated at cross streets, the median width should be 28 feet. For urban freeways, median widths vary up to 30 feet, with 24 feet commonly used.

### **American Association of State Highway and Transportation Officials – Guide for the Development of Bicycle Facilities**

Chapter 6, Section 4 of TxDOT’s *Roadway Design Manual* recommends the use of AASHTO’s *Guide for the Development of Bicycle Facilities* in the planning, design, construction, maintenance, and operation of bicycle facilities. There are two types of bicycle facilities described in this guide: bicycle lanes and bicycle paths. The guide supports bicycle lanes and shared-use paths where vehicular volumes and speeds are higher, and includes multiple warnings against using wide curb lanes as a standard solution for major roadways—they should only be used on roadways with a speed limit of 35 mph or less. The following are the guide’s minimum recommendations by bicycle facility type:

- Shared Lanes on Major Roadways (Wide Curb/Outside Lanes): minimum usable lane width of 14 feet, measured from the center of the edge line to the center of the traffic lane line. The provision of wide outside lanes should be weighed against the likelihood that motorists will travel faster in them and that heavy vehicles will prefer them to inside lanes, resulting in decreased level of service for bicyclists. When sufficient width is available to provide bike lanes or paved shoulders, they are the preferred facilities on major roadways.
- Bicycle Lane: recommended width of 5 feet, measured from the center of the bike lane line to the right edge of the bicycle lane (e.g., curb or gutter). Wider bicycle lanes may be desirable on high-speed (greater than 45 mph) and high-volume roadways, or where there is a substantial volume of heavy vehicles. Along sections of roadway with curb and gutter, a usable width of 4 feet is recommended. Bike lanes should be delineated from the adjacent travel lanes with a solid white line.
- Bicycle Lane: 5 foot width from the face of a curb or guard rail to the bike lane stripe; however, 4 feet of this must be usable. Therefore, if the gutter pan width is 1.5 feet, then the minimum total width is 5.5 feet
- Shared-use Paths (also known as sidepaths when they run adjacent to roadways): width of 10 to 14 feet. Provision of a pathway adjacent to the road is not a substitute for the provision of on-road accommodations such as paved shoulders or bike lanes. The minimum recommended distance between a path and the roadway curb or edge of traveled way is 5 feet (a paved shoulder is not included in this separation distance). Where the separation is less than 5 feet, a physical barrier or railing should be provided between the path and roadway. When a sidepath is placed along a high-speed highway, a separation greater than 5 feet is desirable.

While other types of bikeways may be better suited to accommodate bicycle traffic along roadways, sidepaths should be considered where one or more of the following conditions exist:

- The adjacent roadway has relatively high-volume and high-speed traffic that might discourage many bicyclists from riding on the roadway, and there are no practical alternatives for either improving the roadway or accommodating bicyclists on nearby parallel streets.
- The sidepath can be built with few roadway and driveway crossings

Children and less experienced bicycle users often prefer and/or are encouraged to ride on sidepaths because they provide an element of separation from motor vehicles.

**Institute of Transportation Engineers – Designing Walkable Urban Thoroughfares: A Context Sensitive Approach**

*Designing Walkable Urban Thoroughfares: A Context Sensitive Approach* was approved in 2010 as a recommended practice of the Institute of Transportation Engineers. This manual focuses on applying the concepts and principles of Context Sensitive Solutions (CSS) to an urban thoroughfare environment—facilities designated as arterials or collectors—to support walkable communities. It is intended to supplement and expand on guides and standards commonly used by state and local engineers and planners.

CSS involves planning and designing transportation facilities that:

- Meet the needs of users and stakeholders;
- Are compatible with their setting and preserve scenic, aesthetic, historic and environmental resources;
- Respect design objectives for safety, efficiency, multimodal mobility, capacity and maintenance; and
- Integrate community objectives and values relating to compatibility, livability, sense of place, urban design, cost and environmental impacts.

Not only does context influence the design of thoroughfares, but the design of the thoroughfare itself helps to define and shape the context as much as adjacent land uses and buildings define

and shape context. For these reasons, this document recommends a clear focus on context first, followed by detailed transportation planning.

The guidance in this document should be used as a reference to help the designer create a walkable, context-sensitive thoroughfare.



## **D. BICYCLE AND PEDESTRIAN SAFETY, ACCOMMODATIONS, AND LINKAGES**

### **1.0 Bicycle and Pedestrian Accommodations and Linkages**

The State Highway (SH) 183 corridor should accommodate and provide connections for all modes of transportation and for all users. To accomplish an inclusive design approach, the existing and planned bicycle and pedestrian accommodations along SH 183 and within the study area were analyzed. From this analysis, facility and linkage recommendations can be made to enhance bicycle and pedestrian connectivity in and around the SH 183 corridor. Access management and intersection safety are also addressed from the bicyclist and pedestrian perspective.

#### **1.1 Recommendations for Non-Motorized Network Connectivity**

A number of factors were used to identify and evaluate appropriate bicycle and pedestrian facilities within the SH 183 corridor. This process began with high-level planning and design that provides comfortable connections to destinations such as schools, parks, retail centers, and public transportation.

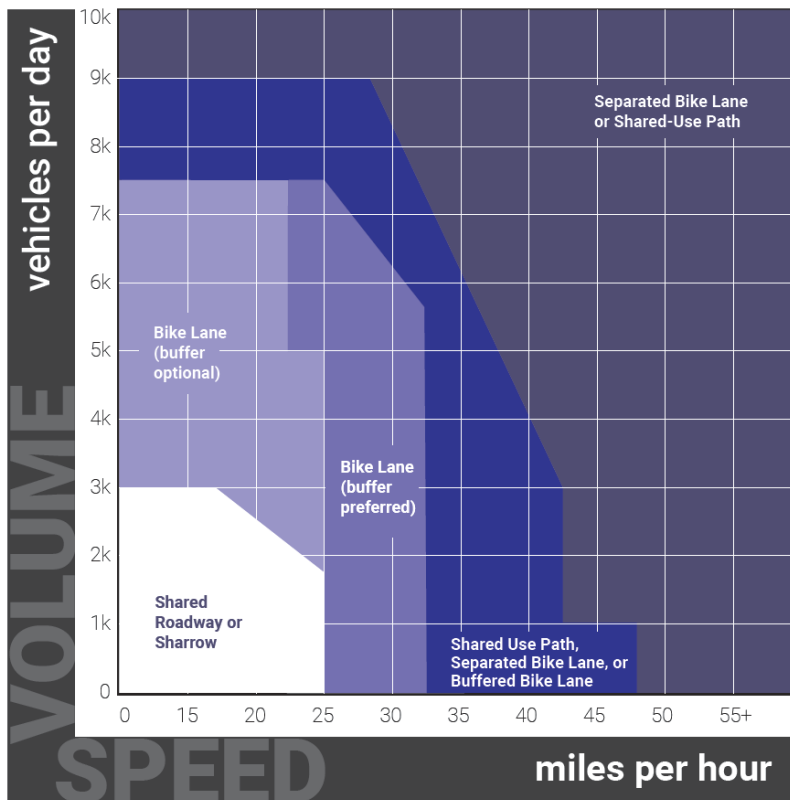
As a minimum, TxDOT design standards for urban streets require the inclusion of five-foot sidewalks on both sides of the roadway with the sidewalks set at least four feet behind the curb. These sidewalks must meet (ADA) design standards. Additionally, a March 2011 TxDOT memorandum titled “Guidelines Emphasizing Bicycle and Pedestrian Accommodations,” established a policy to provide 14-foot outside shared use lanes or a five-foot bike lane on state roads.

However, national research shows that most of the population fits into the “interested but concerned” category with regard to bicycle travel. Therefore, providing low-stress bicycle facilities could increase ridership and create a more comfortable experience for both bicyclists and motorists (see Figure 1). For SH 183, the posted speed limit ranges from 40 mph to 45 mph. The upper value of 45 mph suggests that providing off-street accommodations for both pedestrians and cyclists is necessary (see Figure 2). These facilities could be in the form of an

enhanced sidewalk. A shared-use path or sidepath can accommodate pedestrians as well as all types of bicyclists and could enhance the level of comfort for bicyclists who fall into the “interested but concerned” category and do not feel comfortable riding in traffic conditions.



**Figure 1. Design Users**  
 Source: Toole Design Group, 2017



**Figure 2. Bicycle Facility Selection Guidelines Based on Prevailing Motorist Speeds and Volumes**

Source: Toole Design Group, 2017

Along SH 183, the presence of numerous driveways and cross streets creates conflict points between turning motorists and people walking or bicycling. Techniques to adequately address these conflict points should be considered in the design and operation of the corridor. Shared-

use paths or sidepaths that are spatially separated from vehicular traffic can improve the visibility between bicyclists, pedestrians, and motorists at intersections and driveways if the facility is recessed from the roadway and provides sufficient space for motorists to detect and yield to vulnerable road users in the conflict area. Rather than situating the bicyclist in an area outside a motorist's normal field of vision as an on-street conventional bike lane does, an enhanced sidewalk places bicyclists within the area that a motorist would see in their peripheral vision.

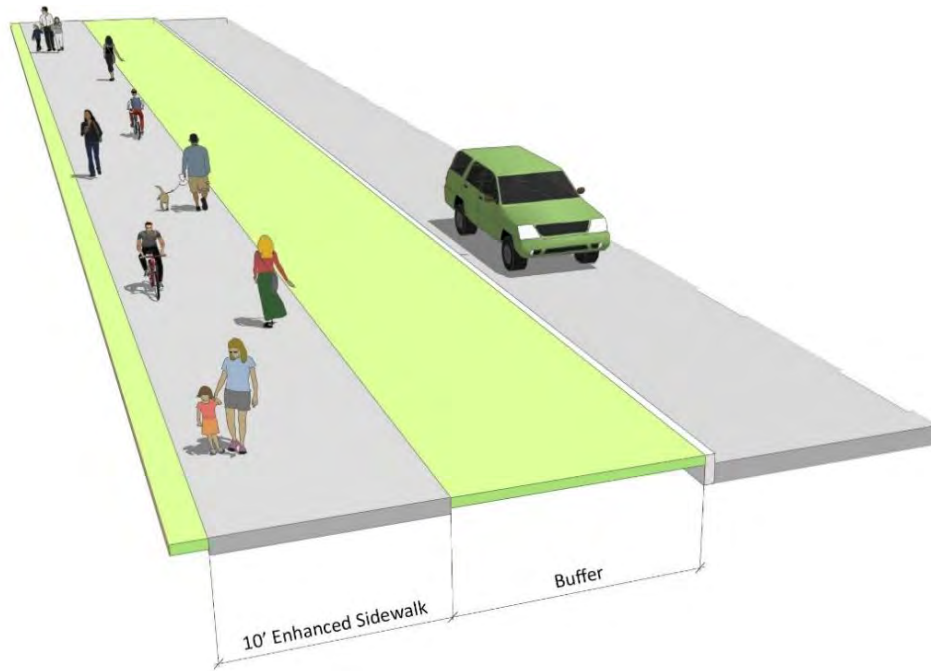
Additionally, it is recommended that sidewalks be separated from the roadway with a buffer (horizontal clearance). TxDOT minimum horizontal clearance width is 4 feet for a standard sidewalk. However, where right-of-way allows, an additional horizontal clearance width is recommended to increase user comfort. Where pedestrian and bicyclist volumes are expected to be high, a striped centerline separating both directions of pedestrian and bicycle traffic should be added for increased safety using a four-inch-wide yellow retroreflective pavement marking material (see Figure 3).



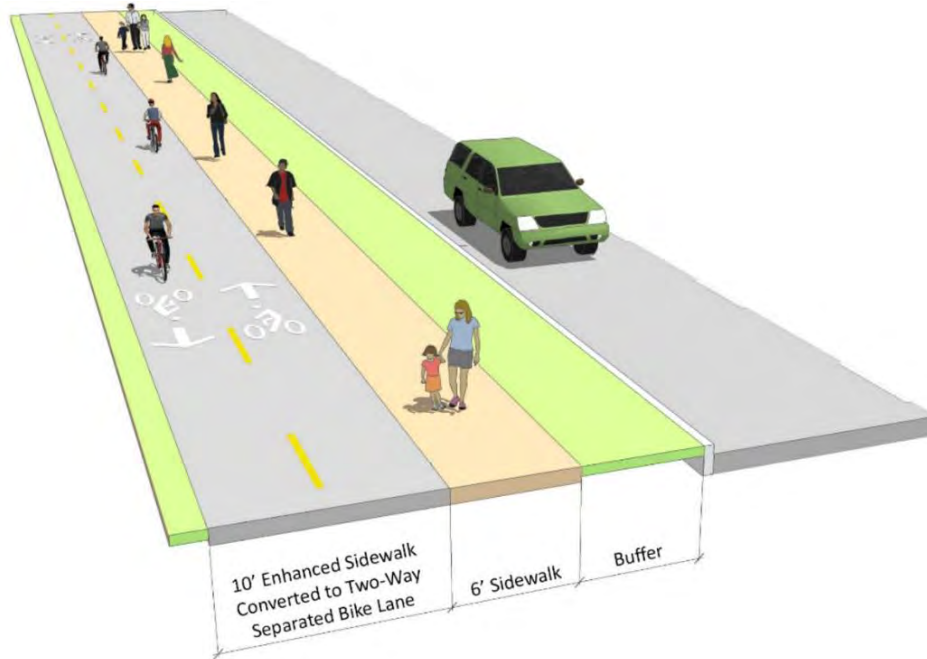
**Figure 3. Shared-Use Path with Centerline Striping**  
Source: Toole Design Group, 2012

With a properly planned buffer width, the shared use path (see Figure 4) could be constructed to 16 feet width based on the volumes of pedestrians and bicyclists using the corridor. This 16

feet width could accommodate a 10-foot-wide two-way separated bike lane with an additional six feet of width for exclusive pedestrian use (see Figure 5). Additionally, if a future release of the TxDOT *Roadway Design Manual* includes flexibility in the geometric design criteria for urban streets, as it is anticipated to include, it is recommended that the outside travel lane width be reduced from 14 feet to 11 feet, and the additional space be repurposed for a separated bicycle facility within the border area.



**Figure 4. Shared-Use Path**  
Source: Toole Design Group, 2017



**Figure 5. Alternative Accommodation: Two-Way Separated Bike Lane and Sidewalk**  
 Source: Toole Design Group, 2017

**2.0 Intersection Safety for Bicyclists and Pedestrians**

Intersections are the most common location of crashes between motorists and vulnerable street users. The following sections highlight best practices for mitigating these crashes.

**2.1 Signage and Pavement Markings**

Proper signage and pavement markings are essential to communicating correct behaviors to all users. This guidance would serve to define travel paths (e.g., lane lines and turn arrows), identify conflict points (e.g., crosswalks), and provide warning and regulatory direction (e.g., Manual on Uniform Traffic Control Devices [MUTCD]) signage including speed limit, stop, yield, and other signs], among other purposes. Signage can also be used for wayfinding and communicating supplementary information, such as the signage installed near accessible push buttons.

If WALK intervals will not be automatically included in the signal cycle at signalized intersections along the SH 183 corridor, signage should be included to notify pedestrians to activate the WALK interval using an accessible push button. Additionally, signage to inform bicyclists to use

the pedestrian push button and cross with the pedestrian WALK indication should be posted at all signalized intersections along the enhanced sidewalk sections of the corridor (MUTCD sign R9-5, see Figures 6 and 7).



**Figure 6. Bicycles Use Ped Signal Sign (R9-5)**

Source: TMUTCD) 2011 Edition. <http://ftp.dot.state.tx.us/pub/txdot-info/trf/tmutcd/2011-rev-2/9.pdf>



**Figure 7. Bicycles Use Ped Signal Sign (R9-5) Installed with Pushbutton**

Source: Toole Design Group, 2017

Furthermore, the installation of designated bicycle crossing locations and bicycle actuated signals may help with bicyclist compliance of traffic signals and improve the safety for all roadway users (Figure 8 and Figure 9).



**Figure 8. Pedestrian and Bicycle Zones**  
Source: NCTCOG, 2017



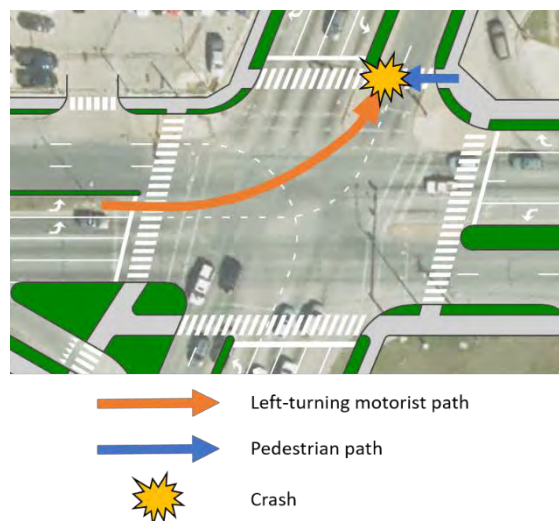
**Figure 9. Bicycle Signals**  
Source: NCTCOG, 2017

At signalized and unsignalized cross street intersections in sections with the enhanced sidewalk, warning signage such as W11-15 (see Figure 26) could be installed on the cross streets at the approaches to SH 183 to warn motorists of the shared use path crossing and the potential presence of bicyclists and pedestrians. This signage should be located in alignment

with the leading edge of the crossing and should have no visual obstructions. Augmented with a recessed crossing, motorists approaching the intersection on the side street would yield on the approach to the enhanced sidewalk crossing, then pull forward to the intersection without blocking the crossing. Additionally, installing high-visibility reflective pavement markings at conflict points would be a straightforward means of identifying locations where all street users should pay extra attention to their surroundings. Maintaining the sidewalk elevation and surface type at driveways, which conveys the message that motorists have not yet entered the street, would help identify these locations and encourage motorist awareness (see Figures 14 and 15).

## 2.2 Protected Left Turns

Pedestrians and bicyclists are vulnerable when in conflict with left-turning traffic at an intersection. Protected left turns minimize the likelihood of a left-turning motorist colliding with a pedestrian or bicyclist in the crosswalk. When left-turn movements are permissive, motorists are often looking for gaps in oncoming opposing traffic and not for the presence of pedestrians in their path (see Figure 10). Particularly at larger intersections, left turns should have exclusive protected phases that do not overlap with pedestrian/bicycle crossing phases so that pedestrians and bicyclists are not present in the intersection when left turns are executed by conflicting traffic.



**Figure 10. Left Turn Conflict with Pedestrian in Crosswalk**  
 Source: Toole Design Group, 2017



At intersections where motorists have unobstructed views of crosswalks, use of a leading pedestrian interval might be justified. Leading pedestrian intervals are a signalization technique wherein the pedestrian phase begins three to seven seconds before the adjacent same-direction green interval begins. This strategy allows pedestrians to enter the crosswalk before motorists enter the intersection and can increase visibility of pedestrians in the crosswalk. Along SH 183, leading pedestrian interval treatments are more applicable at smaller intersections where motorists have the ability to see more of the intersection.

### 2.3 Accessible Pedestrian Signals

As part of the reconstruction of SH 183, new traffic signals would be installed along the corridor. All signalized locations should include accessible pedestrian signals to communicate pedestrian phase information in non-visual formats to pedestrians with visual and/or hearing impairments (see Figure 11 for an example installation).



**Figure 11. Accessible Pedestrian Signal Pushbutton Assembly**

Source: Rivet, Ryan. "New Campus Crosswalks Accommodate the Visually Impaired". *News from Tulane*. Tulane University. [http://www2.tulane.edu/news/newwave/031716\\_aps\\_crosswalks.cfm](http://www2.tulane.edu/news/newwave/031716_aps_crosswalks.cfm). Accessed 22 June 2017.

### 2.4 Bicycle Signals, Detection and Actuation

The installation of bicycle signals and beacons will help improve the safety of bicyclist crossings of roadways, and make crossing intersections safer for bicyclists. Such signals identify when to enter an intersection and help restrict conflicting vehicle movements. According to the National Association of City Transportation Officials (NACTO) Urban Bikeway Design Guide, bicycle detection is used at actuated signals to alert the signal controller of bicycle crossing demand on a particular approach. Bicycle detection occurs either through the use of push-buttons or by automated means (e.g., in-pavement loops, video, microwave, etc). Inductive loop vehicle detection at many signalized intersections is calibrated to the size or metallic mass of a vehicle. For bicycles to be detected, the loop must be adjusted for bicycle metallic mass. Otherwise, undetected bicyclists must either wait for a vehicle to arrive, dismount and push the pedestrian button (if available), or cross illegally.

Proper bicycle detection meets two primary criteria: 1) accurately detects bicyclists; and 2) provides clear guidance to bicyclists on how to actuate detection (e.g., what button to push, where to stand).

Guidance for bicycle signals is available at: <https://nacto.org/publication/urban-bikeway-design-guide/bicycle-signals/> and signal detection and actuation at: <https://nacto.org/publication/urban-bikeway-design-guide/bicycle-signals/signal-detection-and-actuation/>

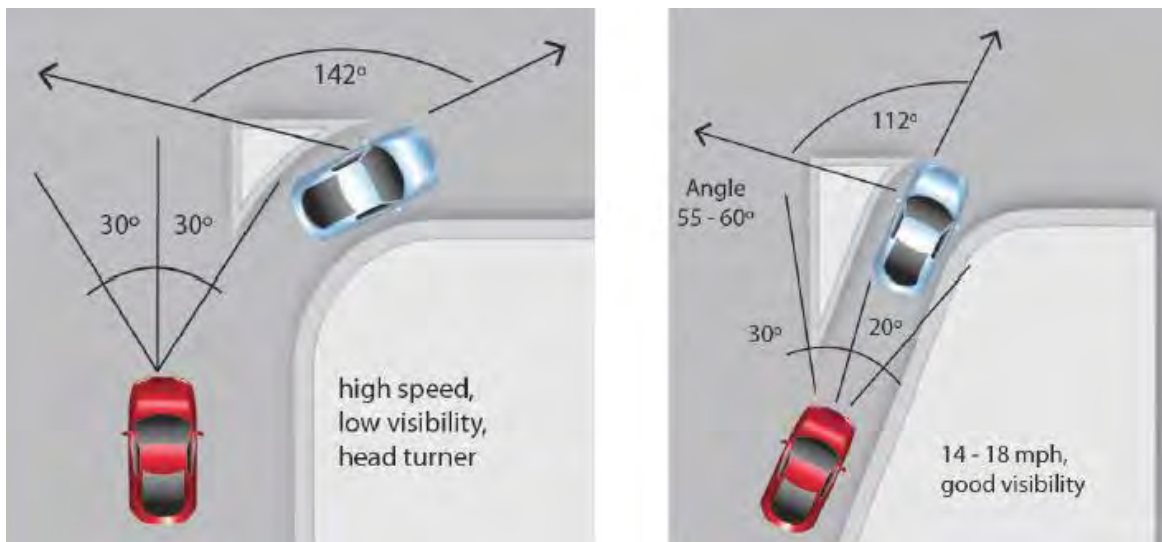
## **2.5 Directional (Perpendicular) Curb Ramps**

All crossings in the redesigned street should have directional (or perpendicular) curb ramps with adequate landing pads instead of diagonal curb ramps. This design would need to accommodate the wider ramps needed for shared use paths. Directional curb ramps orient pedestrians and bicyclists along a straight path to be followed. The alignment of these ramps would be of special significance for visually-impaired pedestrians. Perpendicular curb ramps provide visually-impaired pedestrians with more accurate guidance on which direction to walk than diagonal curb ramps. All curb ramps should include detectable warning devices for ADA compliance.

## 2.6 Modified Turn Lane Geometry

At intersections with a large number of right-turn movements some or all approaches to the intersections may have channelized right-turn lanes based on turning volumes to allow motorists to avoid queues and signal-related delays.

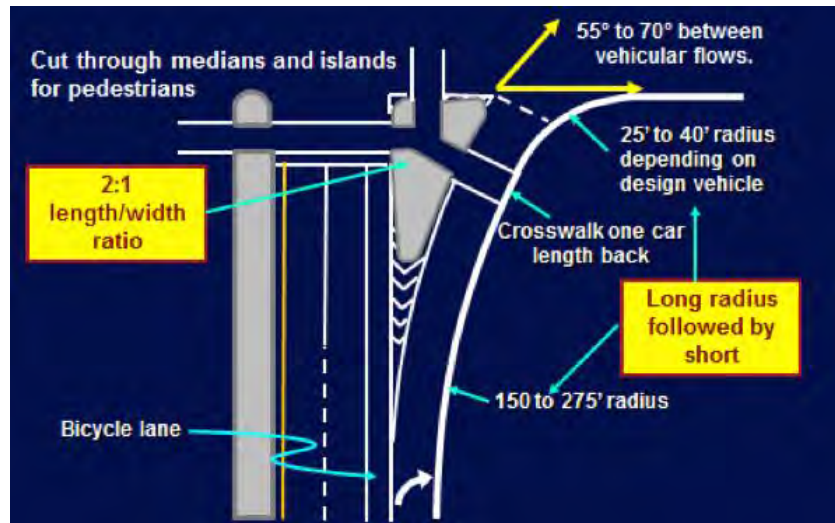
In situations where channelized right-turn lanes are warranted by volumes, it is recommended that the lanes be designed in accordance with the latest Federal Highway Administration (FHWA) guidance, which recommends a sharper angle relative to the angle of the street being entered. This design would require motorists to slow to 14 to 28 mph, allow motorists to more easily see pedestrians or bicyclists in or near the right-turn lane crosswalk, and provide greater visibility of oncoming traffic from the left (see Figures 12 and 13). In addition, the triangle-shaped refuges should have at least 10 feet of storage space to fully accommodate a bicyclist pulling a trailer.



**Figure 12. Recommended Right Turn Lane Angles**

Source: Pedestrian Safety Guide and Countermeasure Selection System (PEDSAFE). FHWA.

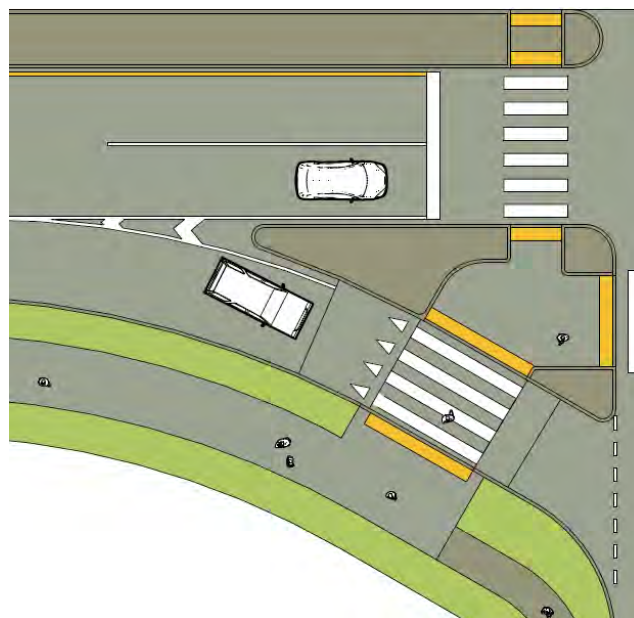
[http://www.pedbikesafe.org/PEDSAFE/countermeasures\\_detail.cfm?CM\\_NUM=24](http://www.pedbikesafe.org/PEDSAFE/countermeasures_detail.cfm?CM_NUM=24) Accessed 28 April 2017.



**Figure 13. Right Turn Lane Crosswalk Design**

Source: PEDSAFE. FHWA. [http://www.pedbikesafe.org/PEDSAFE/countermeasures\\_detail.cfm?CM\\_NUM=24](http://www.pedbikesafe.org/PEDSAFE/countermeasures_detail.cfm?CM_NUM=24) Accessed 28 April 2017.

Another treatment to reduce motorist speeds at right-turn lanes and ease pedestrian and bicyclist crossings is the construction of raised crosswalks. Raised crosswalks would further slow motorist speeds and would increase the visibility of non-motorized street users in the crosswalk (see Figures 14 and 15). Raised crosswalks should be considered in the design of all channelized right-turn lanes in the SH 183 corridor.



**Figure 14. Plan View of Raised Crosswalk at Right Turn Lane**

Source: Toole Design Group, 2017.



**Figure 15. Perspective View of Raised Crosswalk at Right Turn Lane in Boulder, Colorado**

Source: Toole Design Group, 2017.

## 2.7 Recessed Crossings

Recessed crossings should be integrated along the SH 183 corridor, particularly at major driveways where right-of-way is adequate for this design.

The installation of recessed crossings at driveways intersecting SH 183 can reduce the incidence of conflicts between turning vehicles and pedestrians and bicyclists crossing the driveway in the enhanced sidewalk. By setting the crossing back from the intersection, motorists have a refuge space to react and yield to crossing non-motorized users in the crosswalk (see Figure 28). Recessed crossings may also be used at unsignalized intersections and minor signalized intersections. The recommended distance between the roadway and enhanced sidewalk crossing is between 6 and 16.5 feet. In most locations along SH 183, the minimum distance between the curb and right-of-way is 17 feet for the recommended street cross sections, allowing for setback distances on the lower end of this range. The crossing could be raised as well for added visibility and traffic calming. This greater setback to the

crossing would also enhance visibility of vulnerable users as they approach and cross the driveway or cross street.

Similarly, motorists approaching the recessed crossing from the driveway or cross street could stop and look for crossing bicyclists and pedestrians upstream of the crosswalk, proceed across the crosswalk, and have adequate refuge space to look for oncoming traffic from the left before executing their right turn. Without the recessed crossing, motorists often stop in the crosswalk to gain sufficient sight distance to look for a gap in traffic.

## **2.8 Median Refuges and Shorter Crossing Distances**

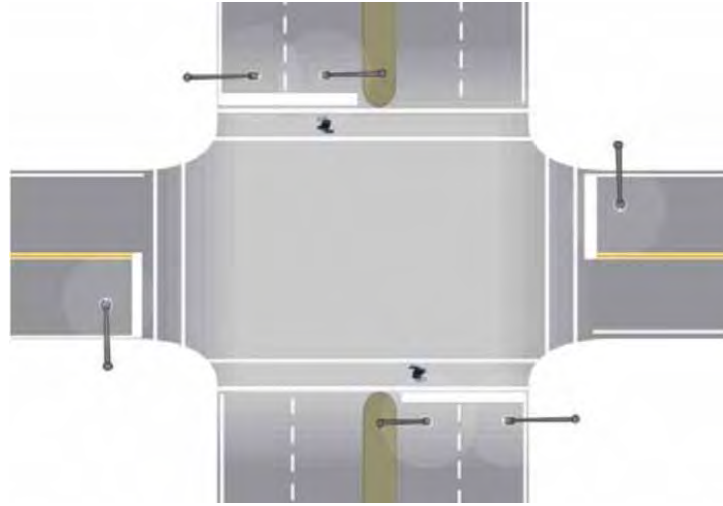
With adequate signal timing, many pedestrians can cross the entire distance of an intersection during the pedestrian phase. However, those pedestrians who cannot become stranded in the middle of the street when the pedestrian phase ends. Wherever possible, pedestrian refuges should be considered (see Figure 14). These refuges should include detectable warning devices for ADA compliance.

## **2.9 Lighting**

Appropriate lighting along the roadway, sidewalks, and at intersections would increase the comfort and safety of motorists, pedestrians, and bicyclists and should comply with the *TxDOT Highway Illumination Manual*. Lighting at intersections and crossings would make pedestrians and bicyclists more visible to motorists. Lighting is also useful to provide a greater sense of security for those using the sidewalks. It is particularly important to provide adequate lighting in commercial areas, of which large sections of SH 183 is comprised.

FHWA recommends that luminaires be located away from the intersection and positioned in a way that illuminates the approach sides of the pedestrian, provides a positive contrast between background intersection illumination and the pedestrian, and could be supplemented by vehicle headlights. Figure 16 indicates the luminaire configuration preferred by FHWA for crosswalks at wide streets, including median-located luminaires.

For the SH 183 corridor, the illumination design should illuminate the roadway and the bicycle and pedestrian facility. Illumination where a motorist is required to stop for pedestrian or traffic conflict should be steadily increased approaching the stop and correspondingly decreased leaving the conflict area.



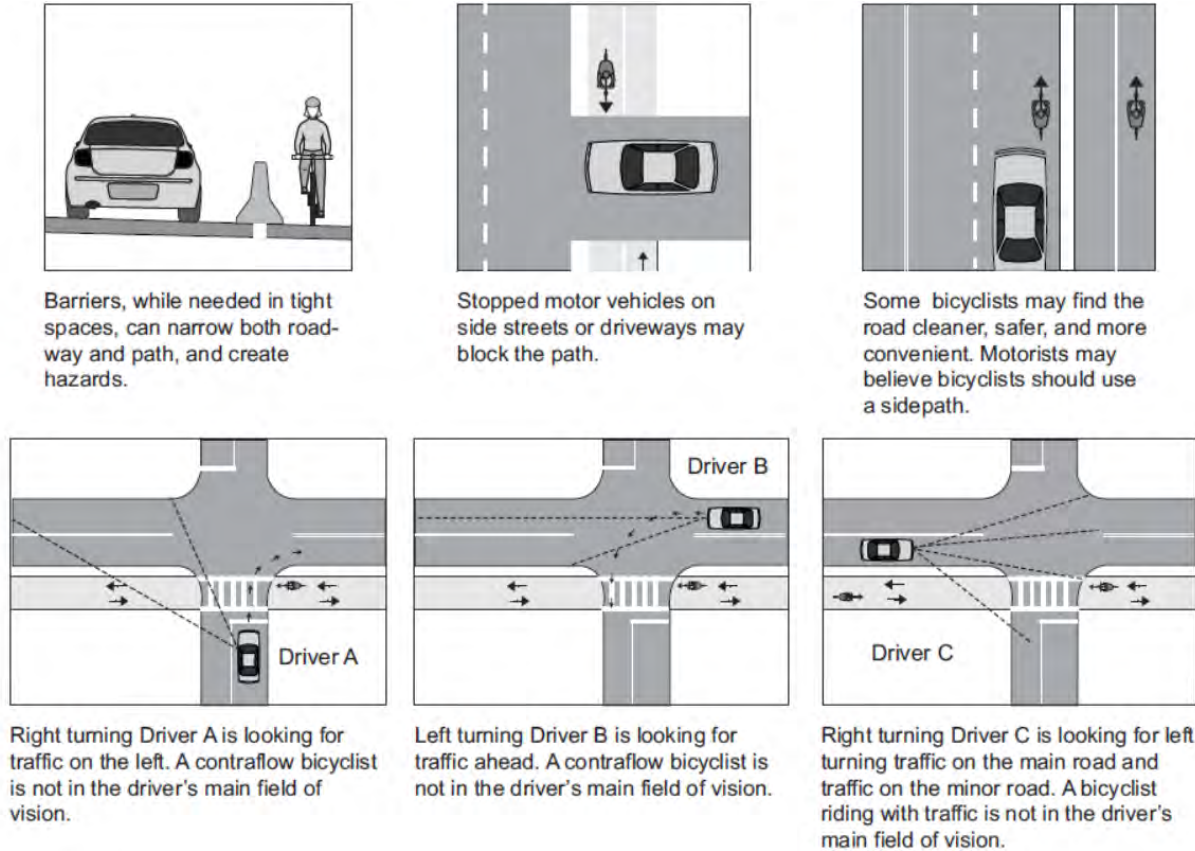
**Figure 16. FHWA-Preferred Intersection Lighting Layout for Crosswalks at Wide Roadways**

Source: Informational Report on Lighting Design for Midblock Crosswalks, FHWA Publication No. FHWA-HRT-08-053, <https://www.fhwa.dot.gov/publications/research/safety/08053/08053.pdf>

### **3.0 Access Management Considerations for Bicycle and Pedestrian Safety**

Every location where a vehicle can enter or leave a roadway creates a potential conflict with through-moving motorists, as well as people walking or riding bicycles, and represents an opportunity for a crash to occur. For vulnerable road users, including pedestrians and bicyclists, these crashes can be particularly severe and even fatal.

The AASHTO guidelines provide a list of 14 potential design and operational complications to be anticipated in the design of shared-use paths adjacent to a roadway (i.e., a sidepath planned for SH 183). Some of these complications are highlighted in Figure 17.



**Figure 17. Sidepath Conflicts**

Source: Figure 5-4, *AASHTO Guide for the Development of Bicycle Facilities*. 4<sup>th</sup> Edition

Most of the operational complications given in the *AASHTO Guide for the Development of Bicycle Facilities* center on visibility issues and conflicts at driveways and cross streets. Proper treatments and design solutions can minimize risks to pedestrians and bicyclists created by the complications cited in the *AASHTO Guide*.

The *TxDOT Access Management Manual*

(<http://onlinemanuals.txdot.gov/txdotmanuals/acm/acm.pdf>) states that one benefit of an effective access management policy is the safety benefit created for pedestrians and bicyclists.

The *TxDOT Access Management Manual* also cites research from the National Cooperative Highway Research Program (NCHRP) which indicates that vehicle crash rates increase exponentially along a corridor as the number of access points increases. TxDOT recommends



that ingress and egress points along a roadway, such as a driveway, be designed so that safety is considered for those moving along the roadway as well as for those using the driveway.

Access management is a critical design factor for bicyclist and pedestrian safety. Driveways present safety risks for bicyclists and pedestrians because every driveway along a street represents one or more conflict points where motorists could strike a vulnerable road user.

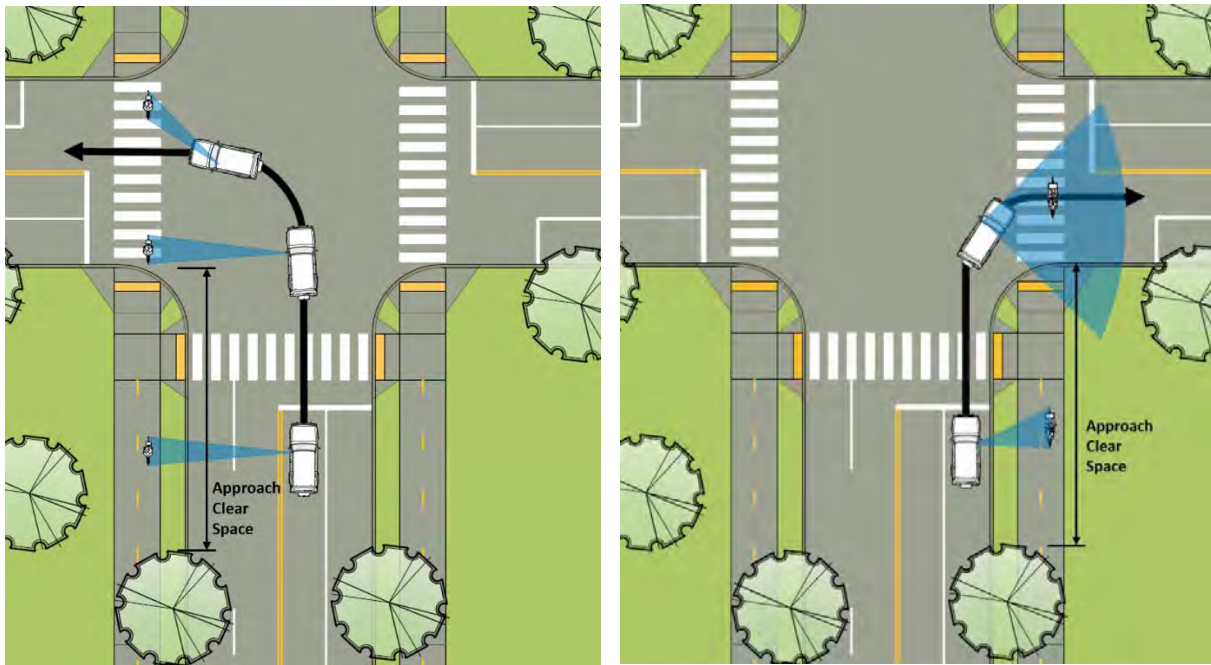
When entering or exiting a traffic stream at a driveway, motorists are often concerned primarily with avoiding conflicts with other motor vehicles and can be less attentive to potential conflicts with pedestrians and bicyclists, who typically move along the outside edges of streets either in a bike lane, sidewalk, or shared use facility. In future design phases, TxDOT would coordinate the location and width of proposed driveways based on current and future land uses, necessary vehicular access, and site circulation. TxDOT representatives would review each property on a case-by-case basis to determine access and driveway needs. All driveway locations and widths would be in accordance with the most recent version of the *TxDOT Access Management Manual* and *TxDOT Roadway Design Manual*.

There are a variety of treatments that could be applied to increase the safety of pedestrians and bicyclists crossing driveway openings. These treatments raise motorists' awareness of vulnerable road users who may be entering the crossing. The treatments also alert bicyclists and pedestrians to look for conflicting motor vehicle traffic.

### **3.1 Geometry and Visibility Enhancements**

The view of sidewalk or bicycle facility approaches should be unobstructed for drivers preparing to turn into a driveway or cross a street. Sight distances and sight triangles based on motorist, bicyclist, and pedestrian speeds should be preserved at all locations where entering or leaving the roadway is permissible. To maintain the approach clear space upstream and downstream of the driveway or access point, trees, tall landscaping, large signs, and other visual barriers should be restricted. Keeping these areas clear of visual obstructions helps ensure that drivers

can detect and react to people who may walk or bicycle across the access point. Figure 18 illustrates the influence of adequate approach clear space on a motorist's ability to see and react to bicyclists when preparing to execute a left and right turn, respectively.



**Figure 18. Approach Clear Space for Left-Turning and Right-Turning Motorists**

Source: Toole Design Group, 2017

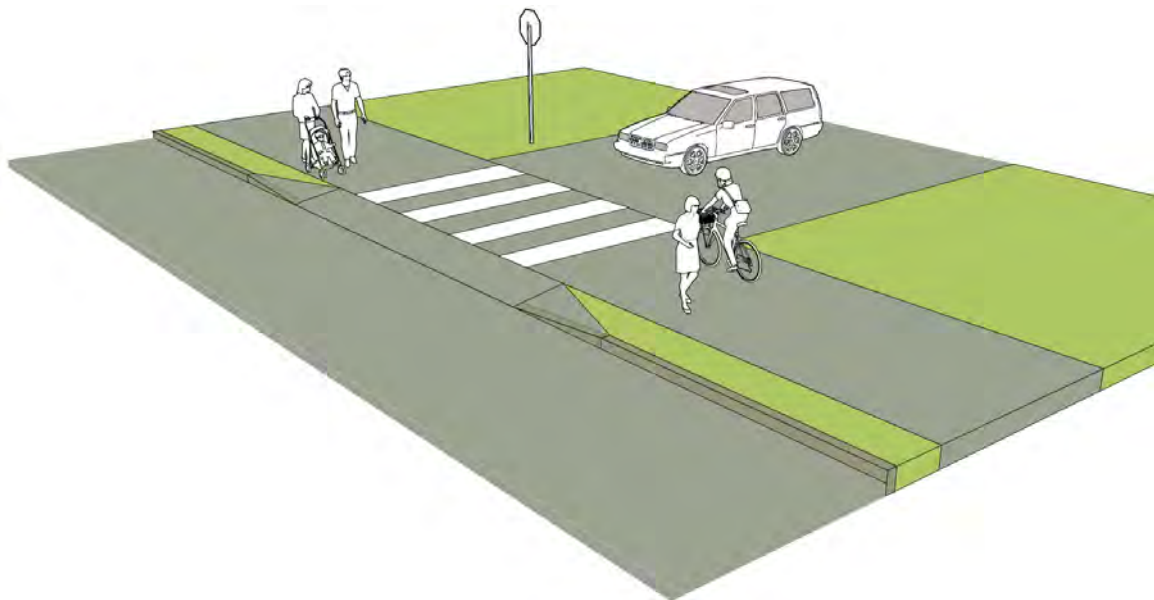
Drivers should be able to clearly see pedestrians or bicyclists approaching the driveway from either direction. The approach clear space needed depends on the speed with which motorists will negotiate the driveway entry. Table 1 provides best practices estimates of the necessary approach clear space on either side of a driveway opening for turning speeds between 10 and 20 mph.

**Table 1. Approach Clear Space Distance by Vehicular Turning Design Speed**

Vehicular Turning Design Speed	Approach Clear Space
10 mph	40 feet
15 mph	50 feet
20 mph	60 feet

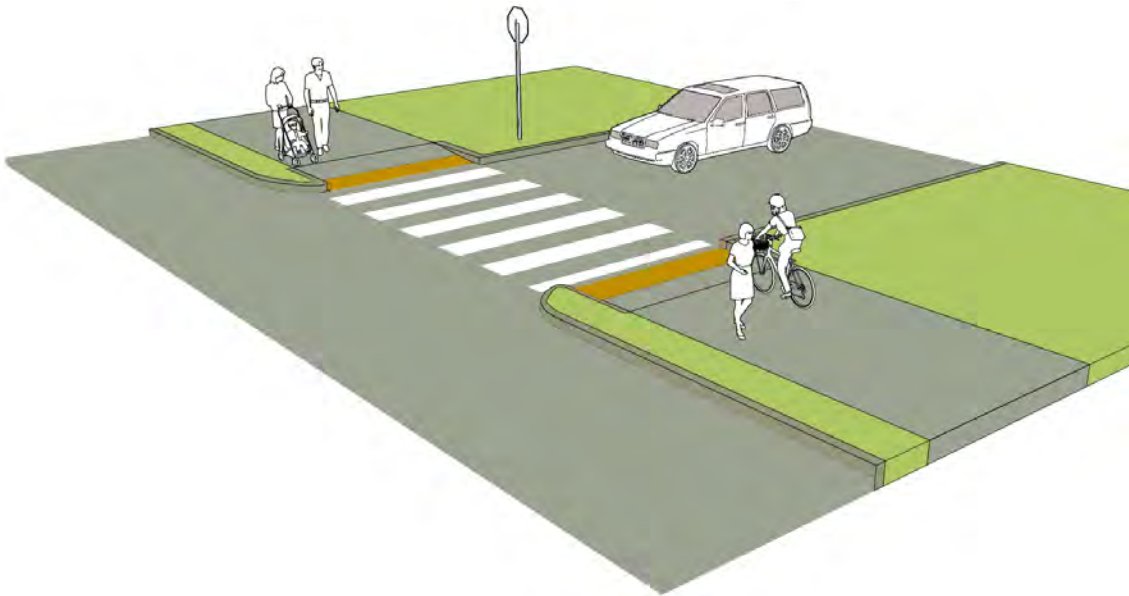
Source: Exhibit 4J, *Separated Bike Lane Planning and Design Guide*. Massachusetts Department of Transportation (MassDOT). <https://www.massdot.state.ma.us/highway/DoingBusinessWithUs/ManualsPublicationsForms/SeparatedBikeLanePlanningDesignGuide.aspx>

In addition to providing adequate clearance on the approaches to a driveway, the sidewalk should continue across the driveway opening to draw attention to the continuity of these facilities (see Figure 19), rather than terminating the sidewalk and bicycle facility at the edge of the driveway and resuming it on the opposite side (see Figure 20). By continuing the sidewalk across the driveway, sidewalk users are prioritized and yielding behavior by motorists is reinforced.



**Figure 19. Continuous Enhanced Sidewalk Across Driveway**

Source: Toole Design Group, 2017



**Figure 20. Discontinuous Enhanced Sidewalk Across Driveway**

Source: Toole Design Group, 2017

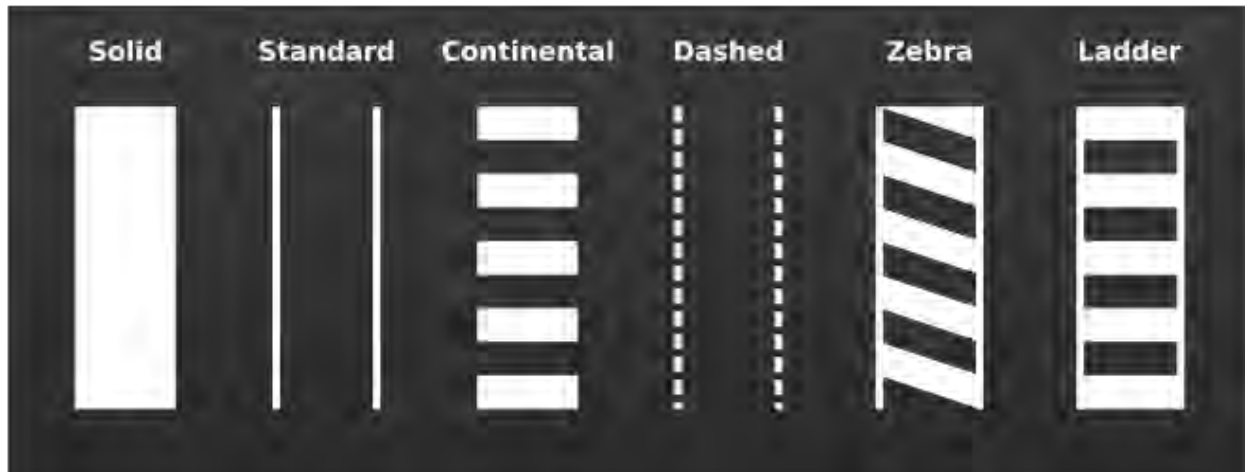
To further encourage slower motorist turning speeds, corner radii at driveways should be reduced to appropriate dimensions for the design vehicle accessing the land use. Smaller, appropriately sized radii induce drivers to slow their vehicles to negotiate the turn. By slowing speeds, this design allows for shorter stopping distances when reacting to the presence of a pedestrian or bicyclist, should the driver fail to see these vulnerable users as they approach the crossing. Slower speeds can also reduce the severity of injuries should a crash occur. Prioritizing driveways for specific uses can ensure a higher number of safe crossings for pedestrians and bicyclists. Since most driveways will only accommodate customers and passenger vehicles, they should be designed as such while appropriate widths and curb radii should be used at entries prioritized for larger delivery vehicles.

### **3.2 Pavement Markings and Signage**

Installing high-visibility reflective pavement markings at conflict points could be an effective means of identifying locations where all street users should pay extra attention to their surroundings. Maintaining the sidewalk elevation and surface type at driveways, which conveys

the message that motorists have not yet entered the street, could help identify these locations and encourage motorist awareness.

High-visibility crosswalks should be installed and maintained at all cross streets and at all driveways if the sidewalk elevation and surface are not maintained at driveways. Continental crosswalk pavement markings 24 inches in width are recommended for the SH 183 corridor due to their greater visibility compared to standard crosswalk pavement markings (see Figure 21). Augmenting the crosswalk markings with pedestrian and bicyclist symbols indicating crossing non-motorized travel in both directions could heighten awareness of motorists entering the crossing.



**Figure 21. Types of Crosswalk Pavement Markings**

Source: Crosswalks | SF Better Streets. <http://www.sfbetterstreets.org/find-project-types/pedestrian-safety-and-traffic-calming/crosswalks/> Accessed: June 16, 2017.

Signage is an important component of raising motorist awareness to the presence and likely movements of vulnerable road users. Alerting motorists entering and exiting driveways to the bidirectional movements of bicyclists and pedestrians in an enhanced sidewalk could help remind motorists to look both ways for these street users and not focus solely on approaching motor vehicles. In an environment like that in the SH 183 corridor, motorists could be looking only to their left for gaps in approaching traffic and not check for bicyclist or pedestrian conflicts

approaching from their right. Motorists should also be reminded to yield the right-of-way to pedestrians and bicyclists, particularly in locations when yielding compliance is poor.

**3.2.1 Signage for Motorists Exiting Driveways and Cross Streets**

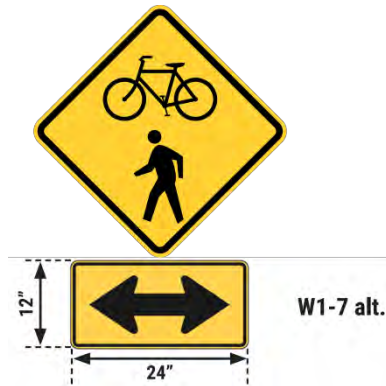
Options for signage could include customized warning signs for motorists exiting driveways and other uncontrolled crossings to notify them of the likely presence of non-motorized traffic crossing the driveway on the enhanced sidewalk. For major driveways, this signage could include assemblies with W11-15 and W16-7P signs (Figure 22). These signs should be placed on either side of the driveway to be visible to motorists as they approach the enhanced sidewalk from the property. If motorists fail to recognize the enhanced sidewalk as a non-motorized facility and attempt to drive on it, signage restricting motor vehicle usage could be added at driveways and cross streets, although this signage should be used only if an ongoing compliance problem is observed.



**Figure 22. Sign Assemblies with W11-15 and W16-7P Left and W16-7P Right**

Source: TMUTCD, 2011. <https://ftp.dot.state.tx.us/pub/txdot-info/trf/tmutcd/2011-rev-2/revision-2.pdf>

Alternatively, the W11-15 sign could be combined with a TWO-WAY supplemental plaque (W1-7) as depicted in Figure 23. This sign assembly could be located at minor driveway crossings where it would be most visible to motorists in advance of the crossing.



**Figure 23. BICYCLE WARNING Sign (W11-15) and TWO-WAY sub-plaque (W1-7 alt.)**

Source: MassDOT Separated Bike Lane Planning and Design Guide.

<https://www.massdot.state.ma.us/highway/DoingBusinessWithUs/ManualsPublicationsForms/SeparatedBikeLanePlanningDesignGuide.aspx>

Some jurisdictions install signage at all major and minor driveways crossing sidepaths. The signage shown in Figure 24 is used extensively in Boulder, Colorado at locations where driveways and parking lot ingress/egress points cross sidepaths.



**Figure 24. Signage for Two-Way Bicycle and Pedestrian Traffic at Driveway**

Source: Toole Design Group, 2017

### 3.2.2 Signage for Motorists Entering Driveways and Cross Streets

At major driveways and cross streets, motorists entering driveways could be warned to yield to pedestrians and bicyclists in the enhanced sidewalk, using a modified version of R10-15, which includes symbols for both a bicyclist and a pedestrian (see Figure 25).



**Figure 25. Turning Vehicles Yield to Bicycles and Pedestrians Sign (R10-15 alt.)**

Source: *MassDOT Separated Bike Lane Planning and Design Guide*.

<https://www.massdot.state.ma.us/highway/DoingBusinessWithUs/ManualsPublicationsForms/SeparatedBikeLanePlanningDesignGuide.aspx>

At minor signalized and unsignalized intersections, it could be useful to install the sign pictured in Figure 26, which is used extensively by the Colorado Department of Transportation at locations where motor vehicle traffic could cross a sidepath facility.



**Figure 26. Adjacent Path Sign**

Source: *Colorado Department of Transportation Roadway Design Guide*.

[https://www.codot.gov/business/designsupport/bulletins\\_manuals/roadway-design-guide/ch14](https://www.codot.gov/business/designsupport/bulletins_manuals/roadway-design-guide/ch14)



### **3.2.3 Signage for Pedestrians and Bicyclists on the Shared Use Path**

It could also be beneficial to people walking and bicycling on the enhanced sidewalk to install signage alerting them to driveway crossings ahead and possible conflicts with motorists. Signage similar to that shown in Figure 27 could be one option.



**Figure 27. Signage to Warn People Walking and Biking on Enhanced Sidewalk of Potential Cross Traffic at Driveway**

Source: Toole Design Group, 2017

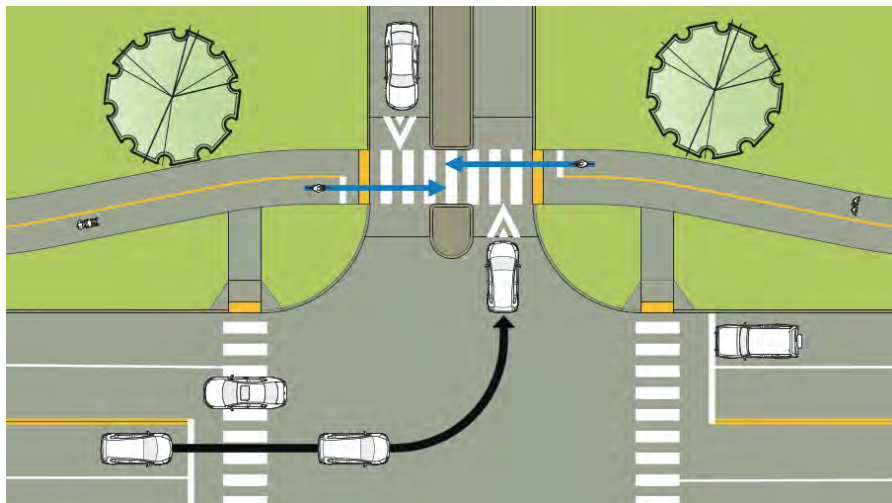
### **3.3 Raised Crossings and Recessed Crossings**

At locations where a sidewalk or bicycle facility crosses driveways or intersections, special precautions should be considered. In the case of motorists attempting a left turn across oncoming traffic into the driveway, the driver might be focused on identifying a gap in the traffic stream and accelerating into the driveway when an adequate gap is found. In such a case, the driver might not observe bicyclists or pedestrians moving into or across the driveway opening. The most effective solution for this scenario is to restrict the left-turn movement with a raised median within the driveway, which eliminates the ability to make higher-speed left turns into the driveway. Similar conflicts could be encountered between right-turning motorists and bicyclists

or pedestrians in the crossing. Two design solutions to help minimize the incidence of these conflicts are raised crossings and recessed crossings.

With the raised crossing, the sidewalk or sidepath crossing is combined with a raised section. Motorist speeds would be reduced by the motorist’s anticipation of negotiating the change in elevation between the street and the crossing. Yielding behavior by motorists would also be reinforced with slower speeds and prioritization of pedestrian and bicyclist travel. In addition, raised crossings would increase the visibility of bicyclists and pedestrians in the crossing.

Recessed crossings, which could be combined with raised crossings as in Figure 28, provide a refuge area for motorists to wait outside the conflicting traffic stream while yielding to bicyclists or pedestrians using the crossing. The greater setback to the pedestrian and bicycle facility, which typically measures between 6 feet and 16.5 feet from the curb face to the edge of the facility, would also enhance visibility of vulnerable users as they approach and cross the driveway or cross street. Motorists approaching the crossing to enter traffic on the main street could yield and wait for crossing pedestrians and bicyclists, then advance to a position on the opposite side of the crossing to look for gaps in traffic without obstructing pedestrians and bicyclists in the crossing.



**Figure 28. Recessed and Raised Crossing at Enhanced Sidewalk**

Source: Toole Design Group, 2017

Along sections of the SH 183 corridor that include a sidepath and available right-of-way, recessed crossings should be provided at all intersections and driveways, and raised crossings should be considered at all locations where geometry allows. High-visibility crosswalk markings should be implemented at all intersections and driveways, particularly if the sidewalk surface is not continued across the crossing. Warning signage to increase motorist awareness should be included at all intersections and major driveways.